

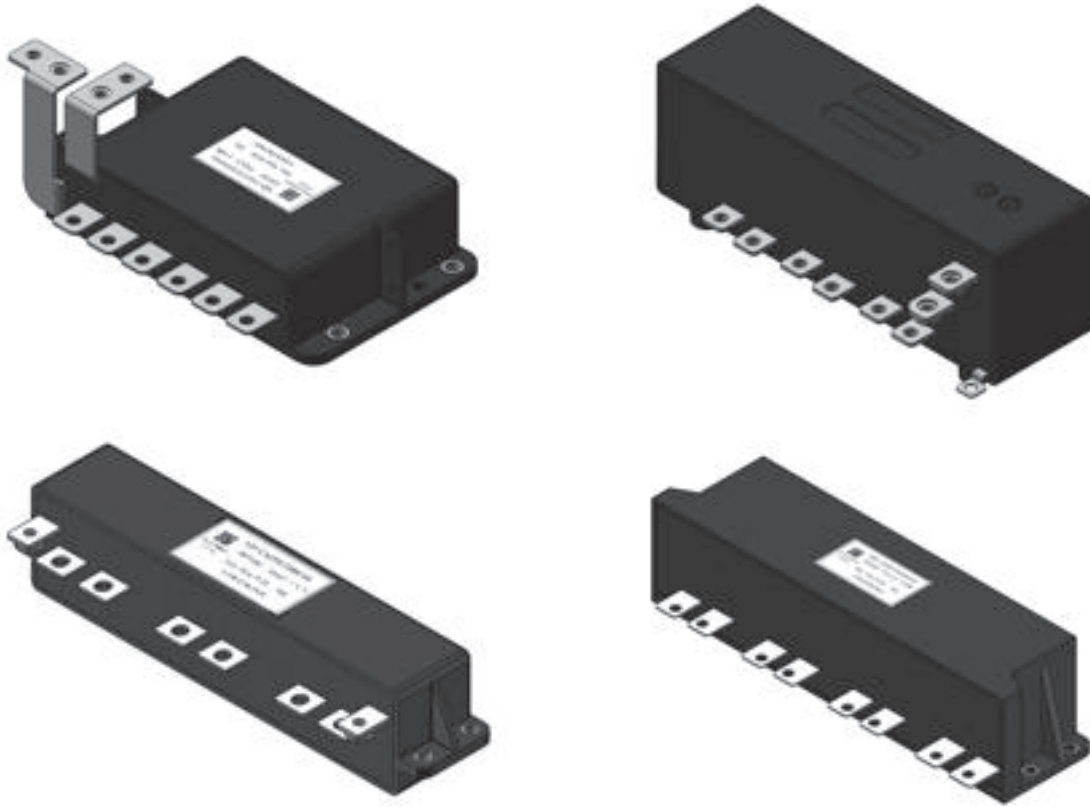

C36

干式直流滤波电容器 (定制品) DC-Link Capacitor (Customized products)

■ 外形图 Outline Drawing



■ 特点

- 应用于直流滤波电路中，可替代电解电容
- 等效串联电阻小，能承受大的纹波电流
- 自感小
- 有自愈性
- 寿命长
- 树脂灌封

■ 应用场合

- 交通工具，如：电动车和混合动力车

■ 预期寿命曲线 Expected lifetime curve

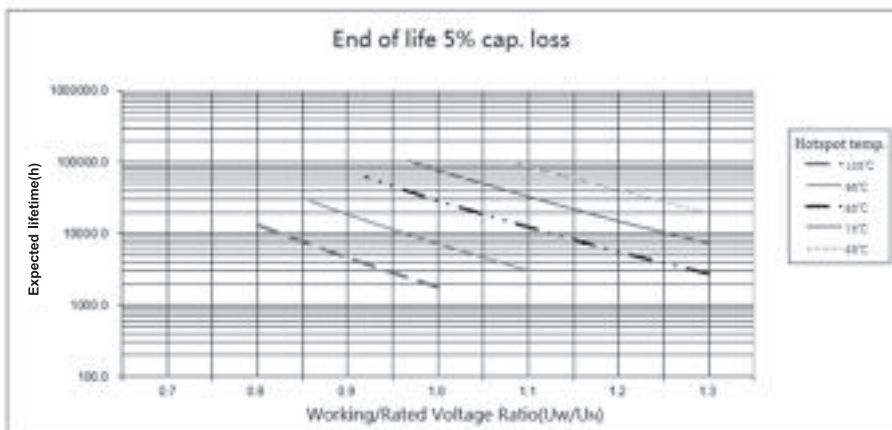

■ Features

- Used in DC-Link circuits, can replace electrolytic capacitor
- Low ESR, high ripple current handling capabilities
- Low Ls
- Self-healing property
- Long lifetime
- Filled with resin

■ Applications

- Transportation: EV or HEV

■ 产品代码 Part number

C362S757K0****

■ 技术参数 Technical data

引用标准 Reference Standard	GB/T 17702(IEC 61071)、AEC-Q200D-2010	
气候类别 Climatic Category	40/105/56	
工作温度范围 Operating Temperature Range	-40°C ~ 105°C ($\Theta_{hs} \leq 105^\circ\text{C}$)	
贮存温度范围 Storage Temperature Range	-40°C ~ 105°C	
额定电压 (U_N) Rated Voltage	450Vdc	
额定容量 (C_N) Rated capacitance	750 μ F	
电容量允许偏差 Capacitance Tolerance	$\pm 10\%$ (K)	
耐电压 Voltage Proof	极间 Between Terminals:	1.5 U_N (10s, 20°C $\pm 5^\circ\text{C}$)
	极壳之间 Between Terminals And Case:	3 000Vac (10s, 50Hz, 20°C $\pm 5^\circ\text{C}$)
介质损耗角正切 $\tan \delta_d$	2×10^{-4}	
IR $\times C_N$	$\geq 10\,000\text{s}$ (20°C, 100Vdc, 1min)	
等效串联电阻 ESR (10kHz)	$\leq 0.36\text{m}\Omega$	
自感 L_s	$\leq 16\text{nH}$ @1MHz (measure at center of holes)	
热阻 (热点到外壳) $R_{thhc}(\Theta_{hs}$ to $\Theta_{case})$	1.2K/W	
最大直流侧电流 Max. I_{rms} for DC	178A ($\Theta_{amb} \leq 85^\circ\text{C}$, $\Theta_{IGBT-terminal} \leq 95^\circ\text{C}$)	
最大纹波电流值 Max. ripple I_{rms}	120A (Continuous@10kHz, $\Theta_{amb} \leq 85^\circ\text{C}$, $\Theta_{IGBT-terminal} \leq 95^\circ\text{C}$)	
\hat{I}	4 300A ($t \leq 10\mu\text{s}$, interval time $\geq 1.3\text{s}$)	
\hat{I}_s	12 900A ($\leq 30\text{ms}$ every time, 1 000 times during lifetime)	
U_s	600Vdc	
爬电距离 Creepage distance	$\geq 5.5\text{mm}$	
电气距离 Clearance	$\geq 5.5\text{mm}$	
预期寿命 Expected lifetime	参考预期寿命曲线 Refer to Expected lifetime curve	
失效率 Failure rate	50 FIT	
尺寸 Dimension(l \times w \times h)	164mm \times 106mm \times 43mm	
重量 Weight	$\approx 1.1\text{kg}$	

* Θ_{case} : 外壳温度;

* Θ_{case} : Temperature of case.

* ESR: 电容器内部串联电阻总和;

* ESR: The sum of all ohmic resistances occurring inside the capacitor.

* $\Theta_{hs} = \Theta_{case} + I_{rms}^2 \times ESR \times R_{thhc}$.



C36

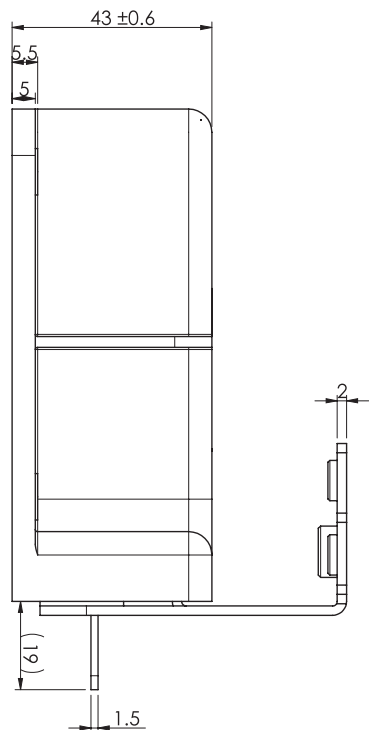
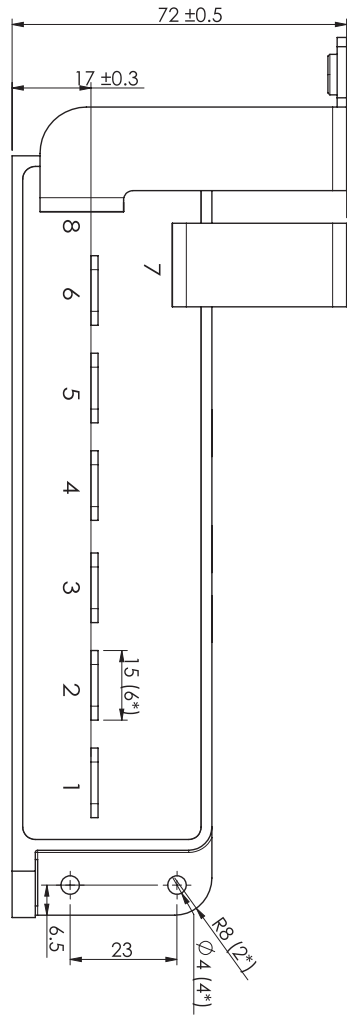
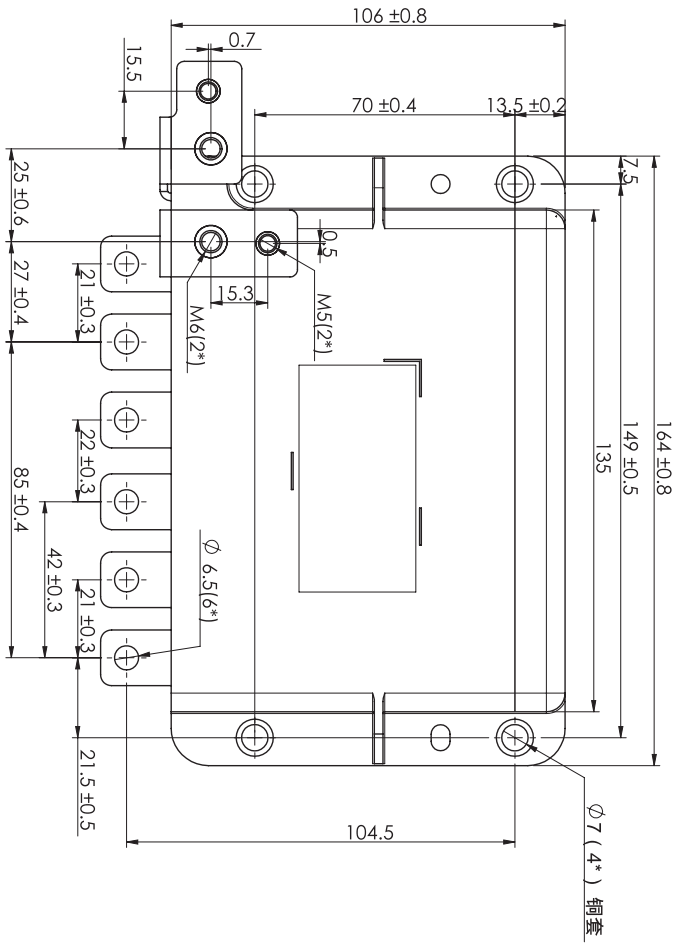

内部连接图

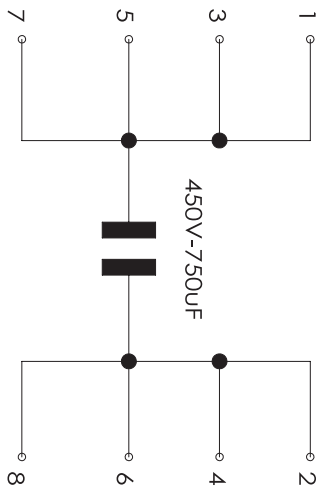

■ 产品代码 Part number

C362H857K2*****

■ 技术参数 Technical data

引用标准 Reference Standard	GB/T 17702(IEC 61071)、AEC-Q200D-2010	
气候类别 Climatic Category	40/105/56	
工作温度范围 Operating Temperature Range	-40°C ~105°C ($\Theta_{hs} \leq 105^\circ\text{C}$)	
贮存温度范围 Storage Temperature Range	-40°C ~105°C	
额定电压 (U _N) Rated Voltage	500Vdc	
额定容量 (C _N) Rated capacitance	850 μ F	
电容量允许偏差 Capacitance Tolerance	$\pm 10\%$ (K)	
耐电压 Voltage Proof	极间 Between Terminals:	1.5U _N (10s, 20°C $\pm 5^\circ\text{C}$)
	极壳之间 Between Terminals And Case:	3 000Vac (10s, 50Hz, 20°C $\pm 5^\circ\text{C}$)
	Y 电容极间 Between Terminals @ClassY:	3 000Vdc (2s, 25°C $\pm 5^\circ\text{C}$)
介质损耗角正切 $\tan \delta_d$	2×10^{-4}	
IR \times C _N	$\geq 10\,000\text{s}$ (20°C ,100Vdc,1min)	
等效串联电阻 ESR (10kHz)	$\leq 0.51\text{m}\Omega$	
自感 L _s	$\leq 15\text{nH}$ @1MHz (measure at center of holes)	
热阻 (热点到外壳) R _{thhc} (Θ_{hs} to Θ_{case})	2.5K/W	
最大直流侧电流 Max. I _{rms} for DC	199A ($\Theta_{cool} \leq 65^\circ\text{C}$, $\Theta_{amb} \leq 65^\circ\text{C}$)	
最大纹波电流值 Max. ripple I _{rms}	170A (Continuous @20kHz , $\Theta_{cool} \leq 65^\circ\text{C}$, $\Theta_{amb} \leq 65^\circ\text{C}$)	
\hat{i}	3 366A (t $\leq 10\mu\text{s}$, interval time $\geq 0.5\text{s}$)	
\hat{i}_s	10 098A ($\leq 30\text{ms}$ every time, 1 000 times during lifetime)	
U _s	667Vdc	
爬电距离 Creepage distance	$\geq 5.5\text{mm}$	
电气距离 Clearance	$\geq 5.5\text{mm}$	
预期寿命 Expected lifetime	参考寿命曲线 Refer to Expected lifetime curve	
失效率 Failure rate	50 FIT	
尺寸 Dimension(l \times w \times h)	203mm \times 68mm \times 60mm	
重量 Weight	$\approx 1.8\text{kg}$	

* Θ_{case} : 外壳温度;

* Θ_{case} : Temperature of case.

* ESR: 电容器内部串联电阻总和;

* ESR: The sum of all ohmic resistances occurring inside the capacitor.

* $\Theta_{hs} = \Theta_{case} + I_{rms}^2 \times ESR \times R_{thhc}$.



C36

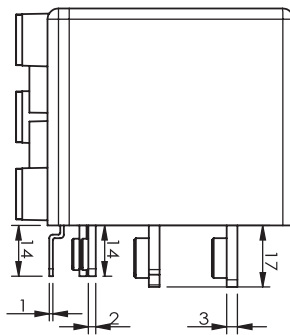
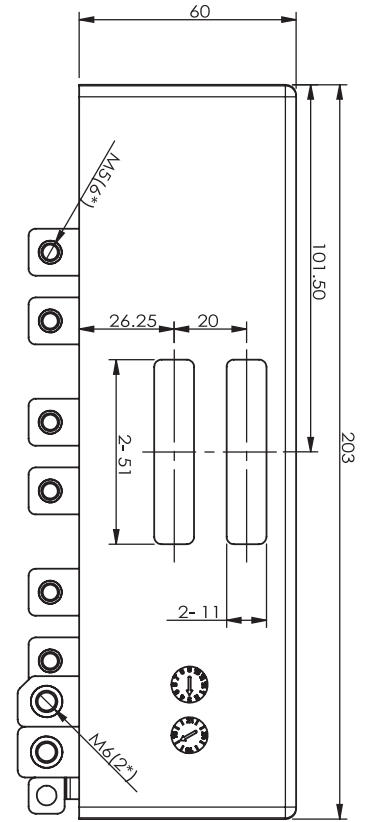
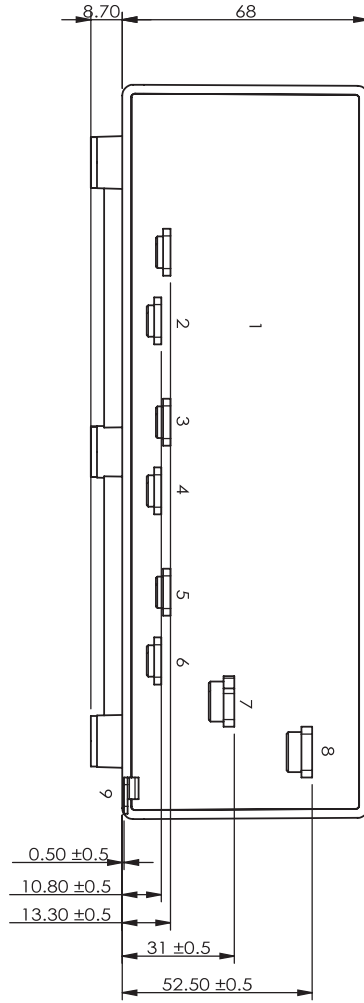
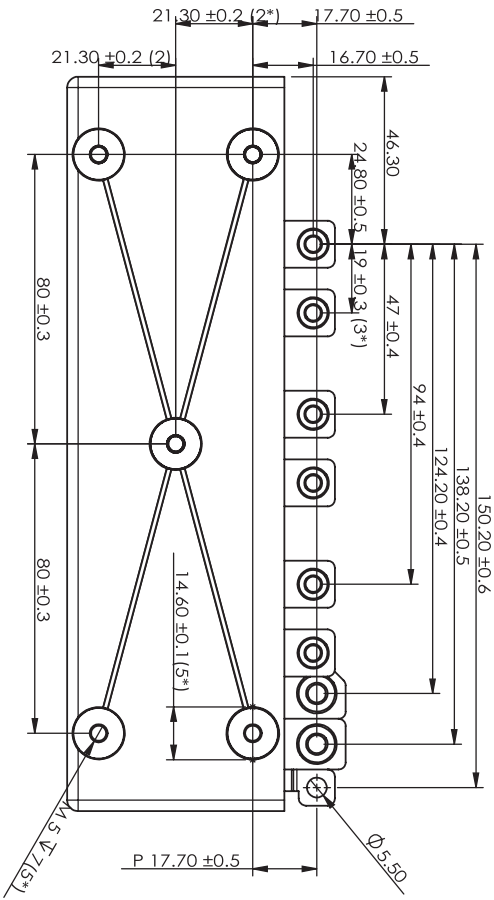

内部连接图

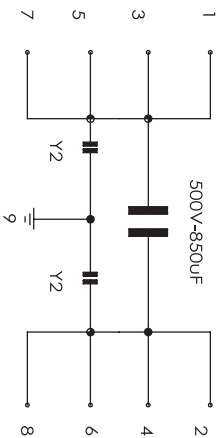

■ 产品代码 Part number

C362S337J0*****

■ 技术参数 Technical data

引用标准 Reference Standard	GB/T 17702(IEC 61071)、AEC-Q200D-2010	
气候类别 Climatic Category	40/105/56	
工作温度范围 Operating Temperature Range	-40°C ~ 105°C ($\Theta_{hs} \leq 105^\circ\text{C}$)	
贮存温度范围 Storage Temperature Range	-40°C ~ 105°C	
额定电压 (U_N) Rated Voltage	450Vdc	
额定容量 (C_N) Rated capacitance	330 μ F	
电容量允许偏差 Capacitance Tolerance	$\pm 5\%$ (J)	
耐电压 Voltage Proof	极间 Between Terminals:	1.5 U_N (10s, 20°C $\pm 5^\circ\text{C}$)
	极壳之间 Between Terminals And Case:	3 000Vac(10s, 50Hz, 20°C $\pm 5^\circ\text{C}$)
介质损耗角正切 $\tan \delta_d$	2×10^{-4}	
IR $\times C_N$	$\geq 10\ 000\text{s}$ (20°C, 100Vdc, 1min)	
等效串联电阻 ESR (10kHz)	$\leq 0.56\text{m}\Omega$	
自感 L_s	$\leq 15\text{nH}$ (measure at center of holes)	
热阻 (热点到外壳) $R_{thhc}(\Theta_{hs} \text{ to } \Theta_{case})$	3.5K/W	
最大直流侧电流 Max. I_{rms} for DC	100A ($\Theta_{cool} \leq 80^\circ\text{C}$, $\Theta_{amb} \leq 85^\circ\text{C}$)	
最大纹波电流值 Max. ripple I_{rms}	85A (Continuous @20kHz, $\Theta_{cool} \leq 80^\circ\text{C}$, $\Theta_{amb} \leq 85^\circ\text{C}$)	
\hat{I}	2 064A ($t \leq 10\mu\text{s}$, interval time $\geq 0.6\text{s}$)	
\hat{I}_s	6 191A ($\leq 30\text{ms}$ every time, 1 000 times during lifetime)	
U_s	600Vdc	
爬电距离 Creepage distance	$\geq 6.9\text{mm}$	
电气距离 Clearance	$\geq 6.9\text{mm}$	
预期寿命 Expected lifetime	参考预期寿命曲线 Refer to Expected lifetime curve	
失效率 Failure rate	50 FIT	
尺寸 Dimension(l \times w \times h)	228mm \times 41mm \times 80mm	
重量 Weight	$\approx 0.75\text{kg}$	

* Θ_{case} : 外壳温度;

* Θ_{case} : Temperature of case.

* ESR: 电容器内部串联电阻总和;

* ESR: The sum of all ohmic resistances occurring inside the capacitor.

* $\Theta_{hs} = \Theta_{case} + I_{rms}^2 \times ESR \times R_{thhc}$.



C36

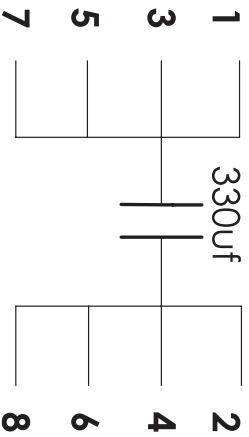
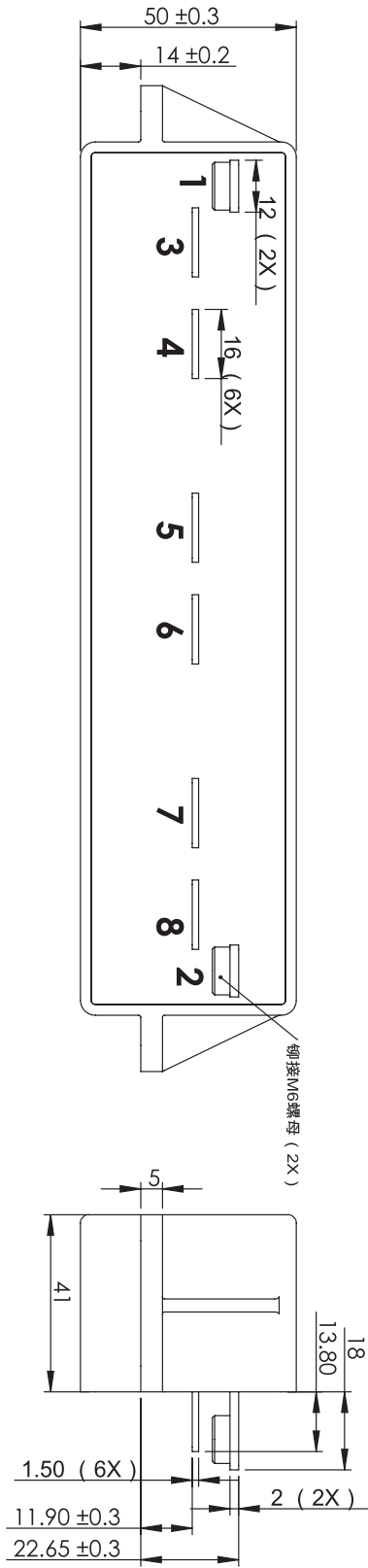
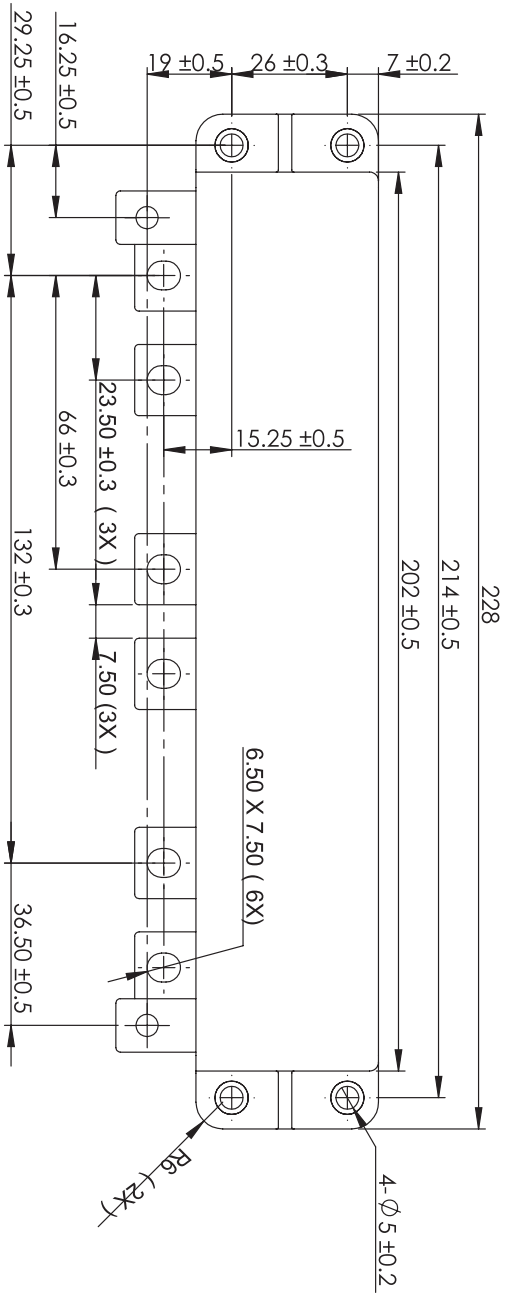

内部连接图

■ 产品代码 Part number

C362K737K0*****

■ 技术参数 Technical data

引用标准 Reference Standard	GB/T 17702(IEC 61071)、AEC-Q200D-2010	
气候类别 Climatic Category	40/105/56	
工作温度范围 Operating Temperature Range	-40°C ~ 105°C ($\Theta_{hs} \leq 105^\circ\text{C}$)	
贮存温度范围 Storage Temperature Range	-40°C ~ 105°C	
额定电压 (U_N) Rated Voltage	800Vdc	
额定容量 (C_N) Rated capacitance	730 μF	
电容量允许偏差 Capacitance Tolerance	$\pm 10\%$ (K)	
耐电压 Voltage Proof	极间 Between Terminals:	1.5 U_N (10s, 20°C $\pm 5^\circ\text{C}$)
	极壳之间 Between Terminals And Case:	3 000Vac (10s, 50Hz, 20°C $\pm 5^\circ\text{C}$)
介质损耗角正切 $\tan \delta_d$	2×10^{-4}	
IR $\times C_N$	$\geq 10\ 000\text{s}$ (20°C, 100Vdc, 1min)	
等效串联电阻 ESR (10kHz)	0.6m Ω	
自感 L_s	$\leq 25\text{nH}$ @1MHz (measure at center of holes)	
热阻 (热点到外壳) $R_{thhc}(\Theta_{hs} \text{ to } \Theta_{case})$	1.6K/W	
最大纹波电流值 Max. ripple I_{rms}	150A (Continuous @20kHz, $\Theta_{cool} \leq 85^\circ\text{C}$, $\Theta_{amb} \leq 85^\circ\text{C}$)	
\hat{i}	5 000A ($t \leq 10\mu\text{s}$, interval time $\geq 1.2\text{s}$)	
\hat{i}_s	15 000A ($\leq 30\text{ms}$ every time, 1 000 times during lifetime)	
U_s	1 067Vdc	
爬电距离 Creepage distance	$\geq 8.5\text{mm}$	
电气距离 Clearance	$\geq 8.5\text{mm}$	
预期寿命 Expected lifetime	参考预期寿命曲线 Refer to Expected lifetime curve	
失效率 Failure rate	50 FIT	
尺寸 Dimension(l \times w \times h)	275mm \times 72mm \times 70mm	
重量 Weight	$\approx 2.2\text{kg}$	

* Θ_{case} : 外壳温度;

* Θ_{case} : Temperature of case.

* ESR: 电容器内部串联电阻总和;

* ESR: The sum of all ohmic resistances occurring inside the capacitor.

* $\Theta_{hs} = \Theta_{case} + I_{rms}^2 \times \text{ESR} \times R_{thhc}$.



C36

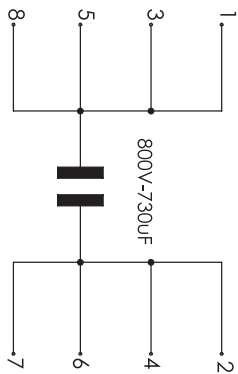
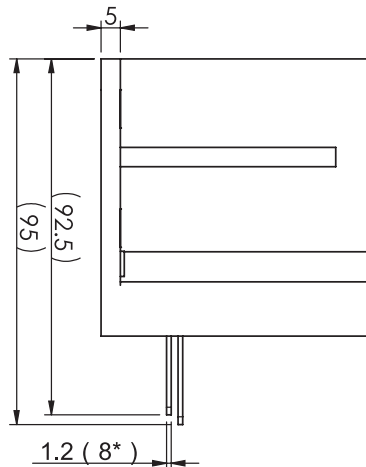
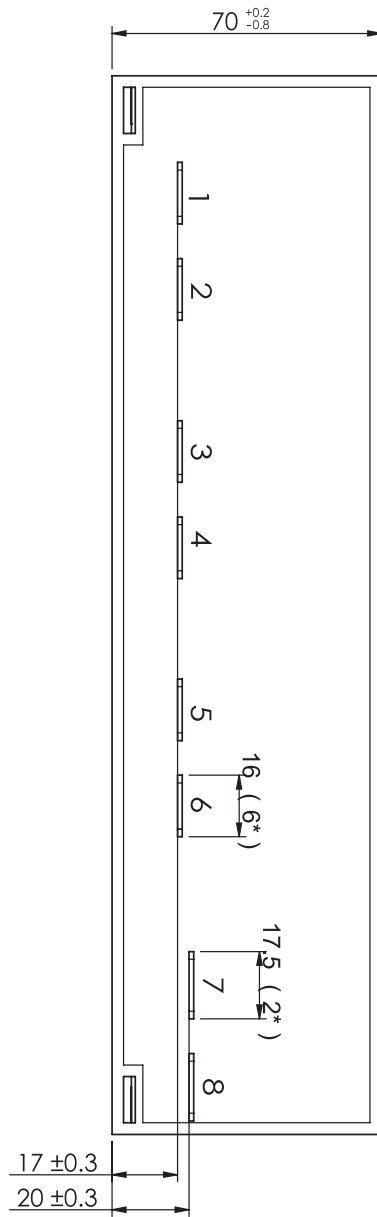
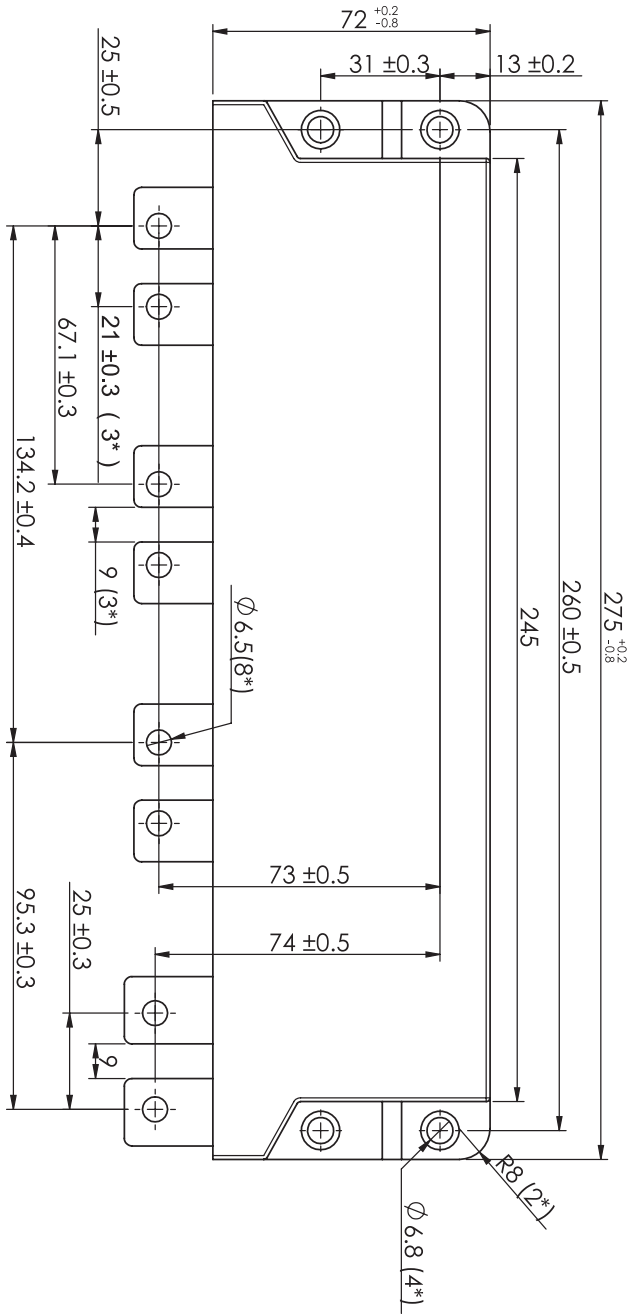

内部连接图