

LTM-XM-336B-0.5-AS

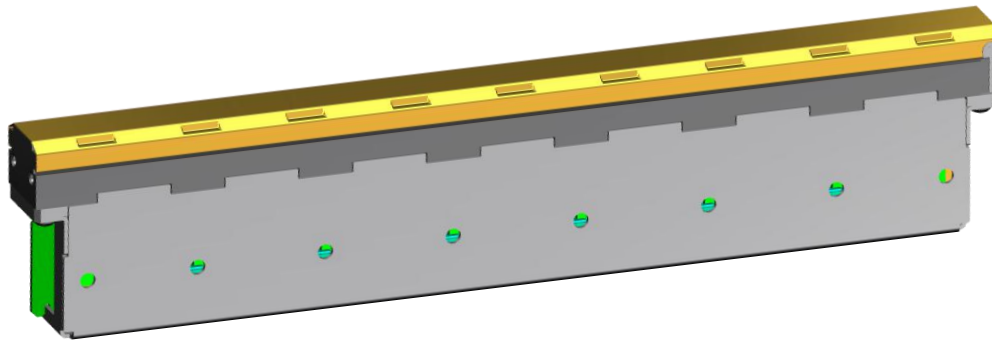

1. Part Numbering

(Part Number)

LTM	XM	336B-0.5-AS	YYWWA000
①	②	③	④

- ① Product family ID
- ② Background Magnet
- ③ Characteristics (336 = channels; B = cover type; 0.5 = channel width in mm; AS = signal output type of the sensor, analog serial output)
- ④ Individual Specification Code

* "(Part Number)" shows only an example which might be different from actual part number.

* Any other definitions than "Product ID" might have different digit number from actual part number.

2. Features

- a) Magnetic mapping sensor based on TMR technology.
- b) High sensitivity and excellent gap characteristics.
- c) Output voltage is independent of scanning speed.
- d) Excellent CMRR performance due to differential design.
- e) Each Sensor has detection width of 179mm, without non-detection area.
- f) LTJ-XM-CH336 has 336x channels and channel width of 0.53 mm.

3. Applications

- a) Bank note validator;
- b) Magnetic ink document reader;
- c) Magnetic image recognition.

4. Parameters

4.1 Absolute parameters

Item	Symbol	Conditions	Rating	Unit
Max. Supply Voltage	$V_a \text{ max}$		-0.5 to 8	V
Supply Current	I_{DD}	$V_{DD} = 5 \text{ V}$	1.0	A
Isolation Voltage	$V_{I \text{ max}}$		200	V
Working Temperature	T_{opg}		-10 ~ +65	Deg.C
Storage Temperature	T_{stg}		-30 ~ +85	Deg.C
Working Humanity	H_{Rh}		10% ~ 90%	
ESD Level (HBM)			2	kV

4.2 Electrical specifications

All specifications are at $T_A = -10 \text{ Deg.C}$ to 65 Deg.C , $V_{DD} = 5\text{V}$, unless otherwise specified.

Item		Min	Typ	Max	Unit
Supply Voltage	V_{DD}	4.75	5	6	V
Work Voltage	V_{CC}		3.3		V
Offset	V_{off}		1.65		V
Sensitivity*	$VP-P$		2		V
Noise	V_{nw}		50		mV
High-level input voltage	V_{IH}	2.0			V
Low-level input voltage	V_{IL}			0.8	V
High-level output voltage	V_{OH}	2.8	3.0		V
Low-level output voltage	V_{OL}		0	0.2	V

* The sensitivity is the output of the sensor when scan the magnetic thread of RMB 100 Yuan at the air gap of 0.1 mm.

4.3 Physical parameters

Item		Part Number	Typ	Unit
Detection Width	W_d	LTJ-XM-CH336	179	mm
Surface Field ϕ	H	LTJ-XM-CH336	850	Gs
Channel width	W_c	LTJ-XM-CH336	0.53	mm

5. Magnetic Sensor Dimensions

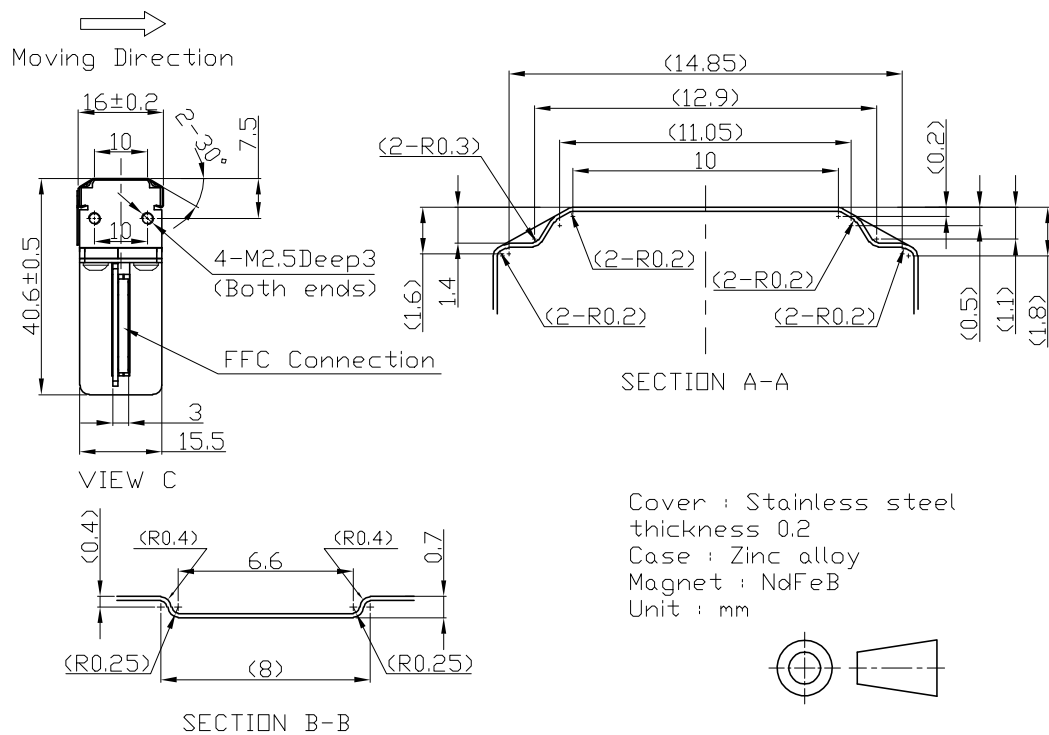
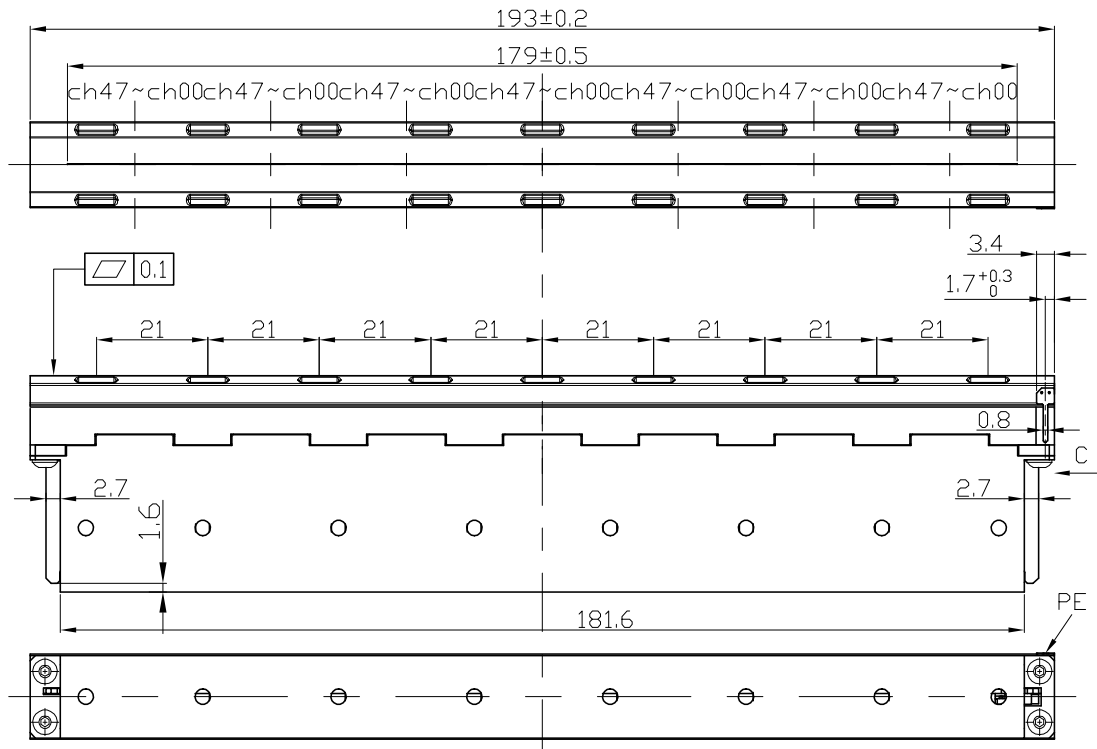

6. Signal Processing

6.1 Pin description

Connector Base Type: 0.5mm FFC connection 22 Pins

CONNECTOR PIN DESCRIPTIONS		
PIN1	GND-Analog	GND for analog circuit
PIN3		
PIN5		
PIN8		
PIN10		
PIN12		
PIN14		
PIN16		
PIN18		
PIN20		
PIN22		
PIN2	CLK	Clock for output of next channel signal
PIN4	RST	Reset the output to first channel signal
PIN6	Vdd	DC supply voltage, 4.75V~6.5V
PIN7		
PIN7	GND-Digital	GND for Digital circuit
PIN9	Vout A	Unit A channels output pin
PIN11	Vout B	Unit B channels output pin
PIN13	Vout C	Unit C channels output pin
PIN15	Vout D	Unit D channels output pin
PIN17	Vout E	Unit E channels output pin
PIN19	Vout F	Unit F channels output pin
PIN21	Vout G	Unit G channels output pin

Pin location description:

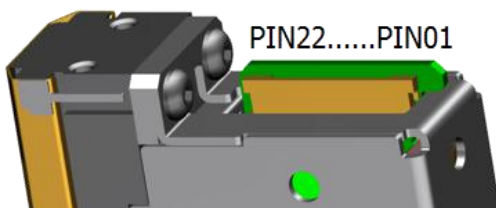

6.2 Signal Processing: Circuit Schematic

LTM-XM-CH336 Sensor

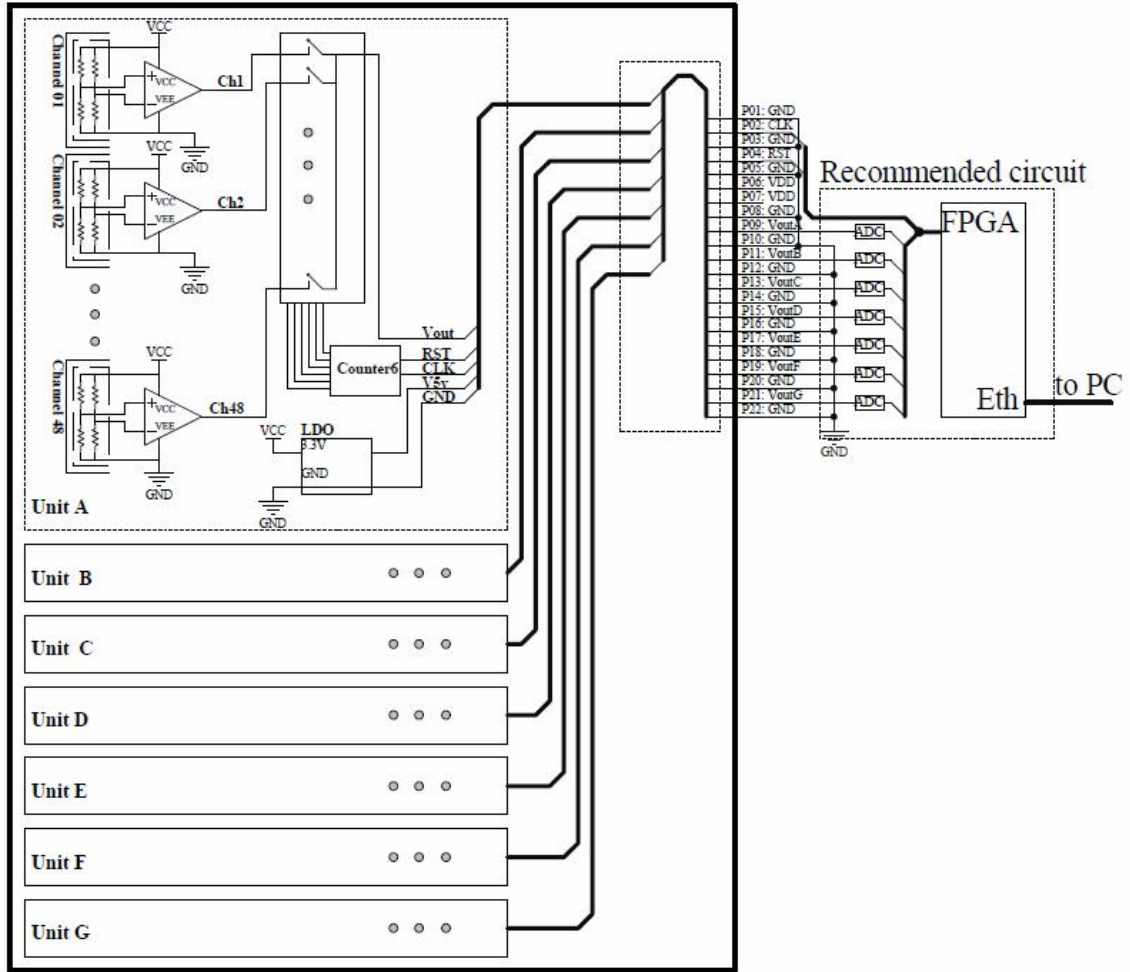

6.3 Signal Processing: Frequency Response

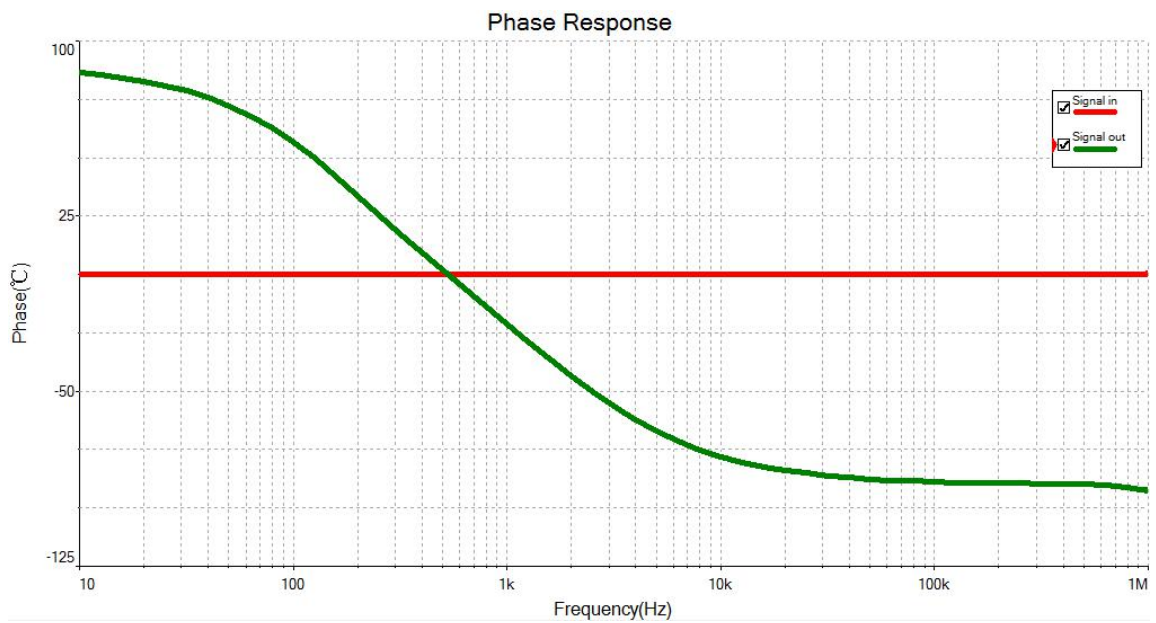
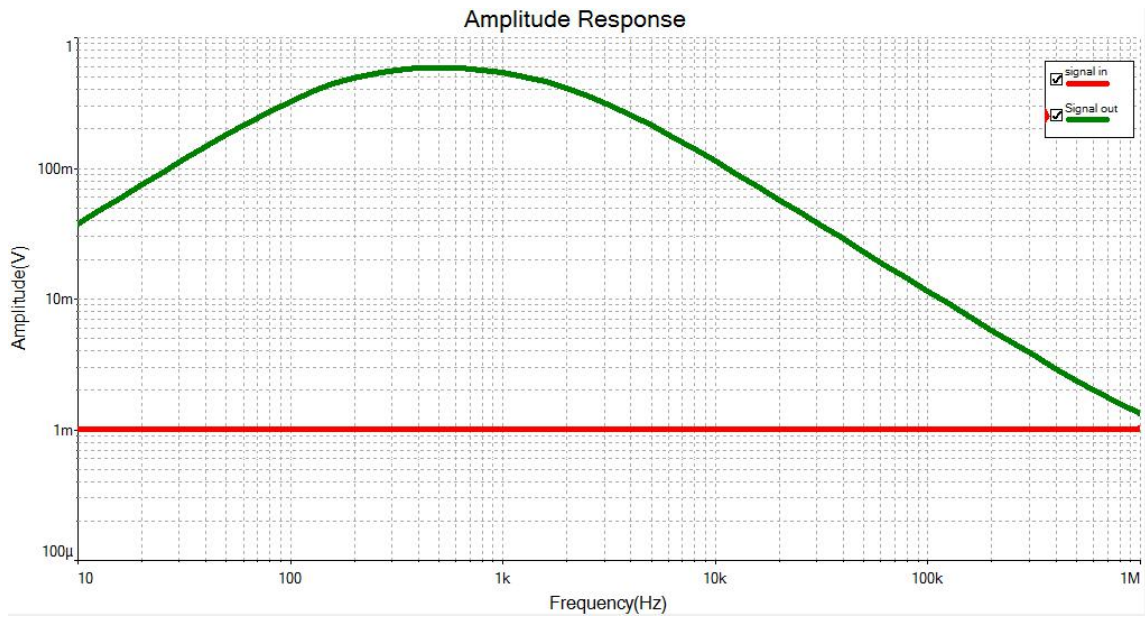

6.4 Signal Processing: Timing Specifications

The following specifications apply for $V_{DD} = 5.0\text{ V}$

Symbol	Parameter	Min	Typ	MAX	Units
fclk	Serial clock frequency			3	MH
DC	SCLK duty cycle	30	50	70	%

