

## for ESD / Surge protection (Sb free) - A series

Part No.	Working Voltage (Vw)	Breakdown Voltage (Vb)	Clamping Voltage 8/20 $\mu$ S		Peak Current (Ip)	Transient Energy (Et)	Typical Capacitance ( C )	
	Volt	Volt	Volt	Amp	Amp	Joule	$\mu$ F	
	< 50 $\mu$ A	1 mA (DC)	Vc	Ic	8/20 $\mu$ S	10/1000 $\mu$ S	1KHz	1MHz
<b>0402</b>								
JMV0402A5R6T301	5.6	7.0~10.0	22.0	1.0	20	0.05	—	300
JMV0402A090T201	9.0	10.0~15.0	32.0	1.0	20	0.05	—	200
JMV0402A140T850	14.0	16.2~19.8	38.0	1.0	20	0.05	—	85
JMV0402A180T550	18.0	21.6~26	45.0	1.0	20	0.05	—	55
<b>0603</b>								
JMV0603A5R6T102	5.6	7.0~10.0	22.0	1.0	30	0.1	1000	—
JMV0603A5R6T351	5.6	7.0~10.0	22.0	1.0	30	0.1	350	—
JMV0603A090T651	9.0	10.0~15.0	30.0	1.0	30	0.1	650	—
JMV0603A090T331	9.0	10.0~15.0	30.0	1.0	30	0.1	330	—
JMV0603A140T451	14.0	16.2~19.8	37.0	1.0	30	0.1	450	—
JMV0603A140T181	14.0	16.2~19.8	37.0	1.0	30	0.1	180	—
JMV0603A180T281	18.0	21.6~26.0	48.0	1.0	30	0.1	280	—
JMV0603A180T111	18.0	21.6~26.0	48.0	1.0	30	0.1	110	—
JMV0603A260T151	26.0	31.0~38.0	62.0	1.0	30	0.1	150	—
JMV0603A260T800	26.0	31.0~38.0	62.0	1.0	30	0.1	80	—
JMV0603A300T101	30.0	37.0~46.0	73.0	1.0	30	0.1	100	—
<b>0805</b>								
JMV0805A5R6T132	5.6	7.0~10.0	22.0	1.0	80	0.1	1300	—
JMV0805A5R6T451	5.6	7.0~10.0	22.0	1.0	40	0.1	450	—
JMV0805A5R6T661	5.6	7.0~10.0	22.0	1.0	40	0.1	660	—
JMV0805A090T781	9.0	10.0~15.0	27.0	1.0	40	0.1	780	—
JMV0805A090T271	9.0	10.0~15.0	27.0	1.0	40	0.1	270	—
JMV0805A120T531	12.0	14.0~18.3	34.0	1.0	40	0.1	530	—
JMV0805A120T431	12.0	14.0~18.3	34.0	1.0	40	0.1	430	—
JMV0805A120T251	12.0	14.0~18.3	34.0	1.0	40	0.1	250	—
JMV0805A140T381	14.0	16.2~19.8	37.0	1.0	40	0.1	380	—
JMV0805A140T201	14.0	16.2~19.8	37.0	1.0	40	0.1	200	—
JMV0805A180T351	18.0	21.6~26.0	48.0	1.0	40	0.1	350	—
JMV0805A180T111	18.0	21.6~26.0	48.0	1.0	40	0.1	110	—
JMV0805A260T161	26.0	31.0~38.0	62.0	1.0	40	0.1	160	—
JMV0805A260T101	26.0	31.0~38.0	62.0	1.0	40	0.1	100	—
JMV0805A300T101	30.0	37.0~46.0	30.0	1.0	40	0.1	100	—
JMV0805A300T311	30.0	37.0~46.0	30.0	1.0	100	0.3	310	—
<b>1206</b>								
JMV1206A5R6T152	5.6	7.0~10.0	22.0	1.0	150	1.0	1500	—
JMV1206A120T801	12.0	14.0~18.3	34.0	1.0	150	0.6	800	—
JMV1206A140T401	14.0	16.2~19.8	37.0	1.0	100	0.3	400	—
JMV1206A140T801	14.0	16.2~19.8	37.0	1.0	200	0.5	800	—
JMV1206A160T132	16.0	19.8~24.2	40.0	1.0	200	1.0	1300	—
JMV1206A180T132	18.0	21.6~26.0	48.0	1.0	200	1.0	1300	—
JMV1206A180T901	18.0	21.6~26.0	48.0	1.0	100	0.3	900	—
JMV1206A260T901	26.0	31.0~38.0	62.0	1.0	200	1.0	900	—



Part No.	Working Voltage (Vw)	Breakdown Voltage (Vb)	Clamping Voltage 8/20 $\mu$ S		Peak Current (Ip)	Transient Energy (Et)	Typical Capacitance ( C )	
	Volt	Volt	Volt	Amp	Amp	Joule	p F	
	< 50 $\mu$ A	1 mA (DC)	Vc	Ic	8/20 $\mu$ S	10/1000 $\mu$ S	1KHz	1MHz
JMV1206A300T201	30.0	37.0~46.0	73.0	1.0	100	0.3	200	—
JMV1206A300T401	30.0	37.0~46.0	73.0	1.0	100	0.3	400	—
JMV1206A300T112	30.0	37.0~46.0	73.0	1.0	200	1.0	1100	—
JMV1206A330T551	33.0	39.0~47.0	75.0	1.0	180	1.0	550	—
JMV1206A380T901	38.0	42.3~51.7	88.0	1.0	200	1.1	900	—
JMV1206A450T551	45.0	50.4~61.6	95.0	1.0	180	0.8	550	—
JMV1206A480T251	48.0	55.8~68.2	100.0	1.0	100	0.8	250	—
JMV1206A560T101	56.0	61.0~77.0	120.0	1.0	100	0.3	100	—
JMV1206A560T381	56.0	61.0~77.0	120.0	1.0	180	1.0	380	—
JMV1206A650T241	65.0	73.8~90.2	135.0	1.0	100	0.6	240	—
<b>1210</b>								
JMV1210A5R6T502	5.6	7.0~10.0	22.0	2.5	250	0.4	5000	—
JMV1210A180T202	18.0	21.6~26.0	48.0	2.5	400	1.5	2000	—
JMV1210A220T182	22.0	24.3~29.7	52.0	2.5	400	1.7	1800	—
JMV1210A260T112	26.0	31.0~38.0	62.0	2.5	250	1.2	1100	—
JMV1210A260T152	26.0	31.0~38.0	62.0	2.5	400	1.9	1500	—
JMV1210A300T901	30.0	37.0~46.0	77.0	2.5	250	1.7	900	—
JMV1210A300T122	30.0	37.0~46.0	77.0	2.5	400	1.9	1200	—
JMV1210A450T951	45.0	50.4~61.6	95.0	2.5	250	2.2	950	—
<b>1812</b>								
JMV1812A180T452	18.0	21.6~26.0	48.0	5	800	2.3	4500	—
JMV1812A220T352	22.0	24.3~29.7	52.0	5	500	2.0	3500	—
JMV1812A220T402	22.0	24.3~29.7	52.0	5	800	2.7	4000	—
JMV1812A260T282	26.0	31.0~38.0	65.0	5	500	2.5	2800	—
JMV1812A260T302	26.0	31.0~38.0	65.0	5	800	3.0	3000	—
JMV1812A300T252	30.0	37.0~46.0	78.0	5	800	3.7	2500	—
JMV1812A380T202	38.0	42.3~51.7	88.0	5	800	4.2	2000	—
<b>2220</b>								
JMV2220A5R6T203	5.6	7.0~10.0	19.0	10	1200	1.4	20000	—
JMV2220A180T153	18.0	22.0~27.0	56.0	10	1200	5.8	15000	—
JMV2220A300T502	30.0	37.0~46.0	85.0	10	1200	9.6	5000	—
JMV2220A380T402	38.0	42.3~51.7	88.0	10	1200	12.0	4000	—

Vw - The max. steady state DC operating voltage of which varistor could maintain also not exceeding 50 $\mu$ A leakage current.

Vb - The voltage acrossed the devic measured at 1mA DC current.

Vc - The peak voltage acrossed the varistor measured at a specified pulse current and waveform.

Ip - The max. peak current applied with specified waveform without any possibility of device fail.

Et - The max. energy which dissipated with the specified waveform without any possibility of device fail.

C - The device capacitance measured with zero volt bias , 1.0 Vrms and 1KHz / 0.5 Vrms and 1MHz.

**\*Any special design or request is welcomed. Please contact our e-mail address : sales@joyin.com.tw**

JOYIN CO.,LTD.  
Metal Oxide Varistor

■ Reliability-Multilayer Chip Varistor

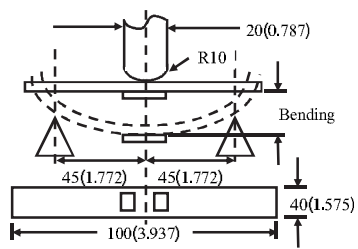
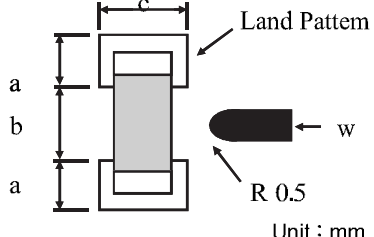
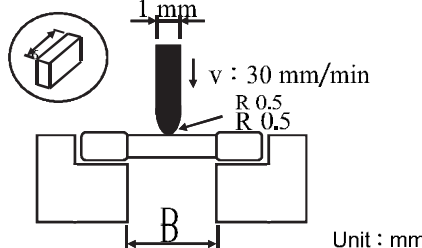
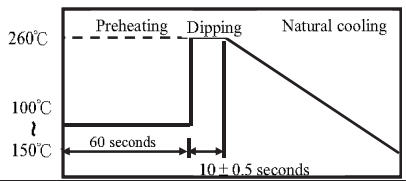
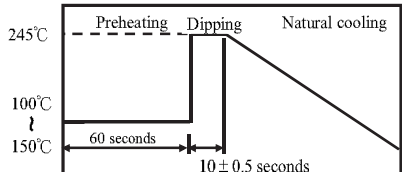
Test description	Standard	Performance	Test condition																																								
Board flexure strength	IEC60068-2-21	No mechanical damage shall be noticed even when the board is bent 2mm (0.079inches)	Solder a chip on a test substrate. Bend the substrat by 2mm(0,079in) 																																								
Flexure strength	Specification Standard	The terminal electrode and chip body must not be damaged by the forces applied. <table border="1" data-bbox="446 918 1013 1064"> <thead> <tr> <th>SIZE</th> <th>0402</th> <th>0603</th> <th>0805</th> <th>1206</th> <th>1210</th> <th>1812</th> <th>2220</th> </tr> </thead> <tbody> <tr> <td>a</td> <td>-</td> <td>1.0</td> <td>1.0</td> <td>1.3</td> <td>1.3</td> <td>1.5</td> <td>1.8</td> </tr> <tr> <td>b</td> <td>-</td> <td>0.8</td> <td>1.0</td> <td>1.5</td> <td>1.5</td> <td>3.6</td> <td>4.6</td> </tr> <tr> <td>c</td> <td>-</td> <td>1.3</td> <td>1.3</td> <td>3.0</td> <td>3.0</td> <td>3.8</td> <td>5.8</td> </tr> <tr> <td>w(kgf)</td> <td>-</td> <td>1.0</td> <td>4.0</td> <td>5.0</td> <td>5.0</td> <td>5.0</td> <td>5.0</td> </tr> </tbody> </table>	SIZE	0402	0603	0805	1206	1210	1812	2220	a	-	1.0	1.0	1.3	1.3	1.5	1.8	b	-	0.8	1.0	1.5	1.5	3.6	4.6	c	-	1.3	1.3	3.0	3.0	3.8	5.8	w(kgf)	-	1.0	4.0	5.0	5.0	5.0	5.0	
SIZE	0402	0603	0805	1206	1210	1812	2220																																				
a	-	1.0	1.0	1.3	1.3	1.5	1.8																																				
b	-	0.8	1.0	1.5	1.5	3.6	4.6																																				
c	-	1.3	1.3	3.0	3.0	3.8	5.8																																				
w(kgf)	-	1.0	4.0	5.0	5.0	5.0	5.0																																				
Bending strength	IEC60068-2-21	The ceramic chip shall not be damaged be the forces applied under the following conditions. <table border="1" data-bbox="446 1220 1013 1310"> <thead> <tr> <th>TYPE</th> <th>0402</th> <th>0603</th> <th>0805</th> <th>1206</th> <th>1210</th> <th>1812</th> <th>2220</th> </tr> </thead> <tbody> <tr> <td>D(mm)</td> <td>-</td> <td>1.3</td> <td>1.3</td> <td>2.0</td> <td>2.0</td> <td>3.8</td> <td>4.8</td> </tr> <tr> <td>W(kgf)</td> <td>-</td> <td>2.0</td> <td>3.0</td> <td>4.0</td> <td>4.0</td> <td>5.0</td> <td>5.0</td> </tr> </tbody> </table>	TYPE	0402	0603	0805	1206	1210	1812	2220	D(mm)	-	1.3	1.3	2.0	2.0	3.8	4.8	W(kgf)	-	2.0	3.0	4.0	4.0	5.0	5.0																	
TYPE	0402	0603	0805	1206	1210	1812	2220																																				
D(mm)	-	1.3	1.3	2.0	2.0	3.8	4.8																																				
W(kgf)	-	2.0	3.0	4.0	4.0	5.0	5.0																																				
Resistance to solder heat	IEC60068-2-20	The ceramic chip shall not be damaged. Shall be covered with solder. Vb: Within ±10% of the initial value.	Preheat:100°C~150°C,60seconds Solder temperature:260±5°C Dip time:10±1 seconds 																																								
Solderability	IEC60068-2-58	More than 90% of terminal electrode shall be covered with solder.	Preheat:100°C~150°C,60seconds Solder temperature:245±3°C Dip time:3±0.3seconds 																																								

過電壓保護



JOYIN CO.,LTD.  
Metal Oxide Varistor

■Reliability-Multilayer Chip Varistor

Test description	Standard	Performance	Test condition
High temperature Load	IEC61051-1	Appearance:ceramic chip shall not be damaged. Vb:Within $\pm 10\%$ of the initial value	Temperature: $85 \pm 2^\circ\text{C}$ Testing time: $1000 \pm 24$ hours Load Voltage:Working voltage Measurement : After placing for 24 hours min.
Damp Heat Load, Steady State	IEC60068-2-78	Appearance:ceramic chip shall not be damaged. Vb:Within $\pm 10\%$ of the initial value	Humidity:90 to 95% RH Temperature: $40 \pm 2^\circ\text{C}$ Testing time: $500 \pm 24$ hours at $V_{bc}$ Measurement : After placing for 24 hours min.
Rapid Change of Temperature	IEC61051-1	Appearance:Cracking, chipping or any other defects harmful to the characteristics shall not be allowed Vb:Within $\pm 10\%$ of the initial value	Temperature: $-40, +125^\circ\text{C}$ , Keeping 30 minutes Cycle:100 cycles Measurement : After placing for 24 hours min.
Low temperature storage	IEC61051-1	Appearance:Cracking, chipping or any other defects harmful to the characteristics shall not be allowed Vb:Within $\pm 10\%$ of the initial value	Temperature: $-40 \pm 5^\circ\text{C}$ Testing time: $1000 \pm 24$ hours Measurement After placing for 24 hours min.
High temperature storage	IEC61051-1	Appearance:Cracking, chipping or any other defects harmful to the characteristics shall not be allowed Vb:Within $\pm 10\%$ of the initial value	Temperature: $125 \pm 5^\circ\text{C}$ Testing time: $1000 \pm 24$ hours Measurement After placing for 24 hours min.
Max. Energy	Specification Standard	Appearance:ceramic chip shall not be damaged. Vb:Within $\pm 10\%$ of the initial value	10/1000us Waveform, Wmax, 1 surge current
ESD test	IEC61000-4-2	Appearance:ceramic chip shall not be damaged. Vb:Within $\pm 50\%$ of the initial value  (For MLV- P/C/E/JES application test only)	Discharge:Air discharge Voltage:15kV Polarity: +, - Number:10 times in 10 seconds. Discharge: Contact discharge Voltage:8kV Polarity: +, - Number:10 times in 10 seconds.

過電壓保護

## Carrier Tape Specifications

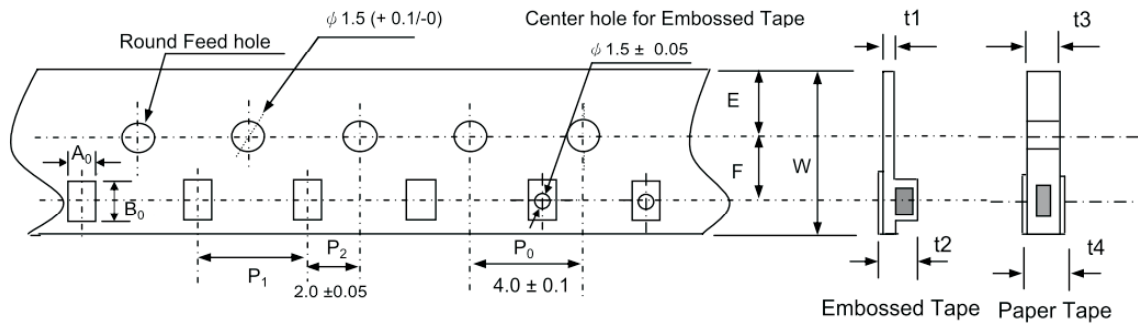

## Dimensions of Embossed Tape

Size	A <sub>0</sub> ±0.1 (mm)	B <sub>0</sub> ±0.1 (mm)	P <sub>1</sub> ±0.1 (mm)	t <sub>1</sub> /t <sub>2</sub> (mm)	t <sub>3</sub> /t <sub>4</sub> (mm)	Quantity/Reel(Pcs)	
						Paper Tape	Embossed Tape
0402	0.62	1.10	2	—	1.0max/ 1.1max	10000	—
0603	1.08	1.88	4	—	1.0max/ 1.1max	4000	—
0805	1.42	2.30	4	0.6max/2.0max	1.0max/ 1.1max	4000	4000
1206	1.88	3.50	4	0.6max/2.9max	—	—	3000
1210	2.18	3.46	4	0.6max/2.9max	—	—	2000
1812	3.66	4.95	8	0.6max/2.9max	—	—	1000
2220	5.10	5.97	8	0.6max/2.9max	—	—	1000

A<sub>0</sub> : Width of Cavity  
 B<sub>0</sub> : Length of Cavity  
 P<sub>1</sub> : Pitch

t<sub>1</sub> : Embossed Tape Thickness  
 t<sub>2</sub> : Height of Embossed Tape

t<sub>3</sub> : Paper Tape for Width  
 t<sub>4</sub> : Paper Tape Bottom Width

## Reel Specifications

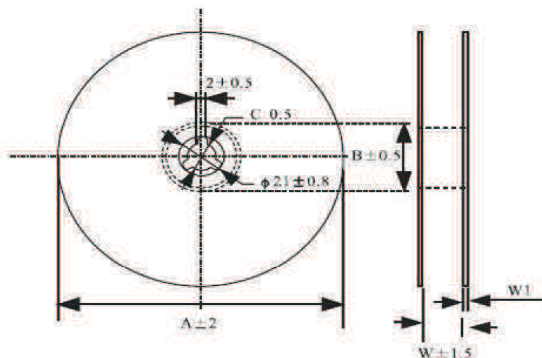

## Dimensions

Size	A	B	C	W	1W
0402	178	60	13	10	1.6
0603	178	60	13	10	1.6
0805	178	60	13	10	1.6
1206	178	60	13	10	1.6
1210	178	60	13	10	1.6
1812	178	60	13.5	13.6	1.6
2220	178	60	13.5	13.6	1.6