



TAI-SAW TECHNOLOGY CO., LTD.

No. 3, Industrial 2nd Rd., Ping-Chen Industrial District,
Taoyuan, 324, Taiwan, R.O.C.

TEL: 886-3-4690038 FAX: 886-3-4697532

E-mail: ttsales@mail.taisaw.com Web: www.taisaw.com

Product Specifications Approval Sheet

Product Description: SAW DPX 831.5 / 876.5MHz Band 26 SMD 1.8X1.4 mm(BW=34.52 MHz)

TST Part No.: TF0137B(This part is compliant with AEC-Q200)

Customer Part No.: _____

Customer signature required
Company: _____
Division: _____
Approved by : _____
Date: _____

Checked by: _____ Anne Chen *Anne Chen*

Approved by: _____ Andy Yu *Andy Yu*

Date: _____ 2018, 11, 30

1. Customer signed back is required before TST can proceed with sample build and receive orders.
2. Orders received without customer signed back will be regarded as agreement on the specifications.
3. Any specifications changes must be approved upon by both parties and a new revision of specifications shall be released to reflect the change



TAI-SAW TECHNOLOGY CO., LTD.

No. 3, Industrial 2nd Rd., Ping-Chen Industrial District,
Taoyuan, 324, Taiwan, R.O.C.

TEL: 886-3-4690038 FAX: 886-3-4697532

E-mail: tstsales@mail.taisaw.com Web: www.taisaw.com

SAW DPX 831.5 / 876.5MHz Band 26 SMD 1.8X1.4mm (BW=34.52 MHz)
MODEL NO.:TF0137B REV.1.0

A. MAXIMUM RATING:

1. Operating temperature range: -40 °C to +85 °C
2. Storage temperature range: -55 °C to +125 °C
3. Input power : 29dB (Ta=+50 °C,5000h,WCDMA modulation)
4. Maximum DC Voltage: +/-3 V
5. Moisture Sensitivity Level: Level 3 (MSL 3)
6. ESD 100V(MM) 200V(HBM)

RoHS Compliant

Lead-free soldering

Electrostatic Sensitive Device (ESD)

B. ELECTRICAL CHARACTERISTICS:

Terminating impedance (Tx Port): 50+5.1nH Ω(Single-ended)

Terminating impedance (Rx Port): 50 Ω (Differential)

Terminating impedance (Ant Port): 50//8.2nH Ω(Single-ended)

Tx to ANT (f_{T0}=831.5 MHz)

Parameters Description		Unit	Min	Typ	Max	Remarks
Insertion Loss	815 ~ 845MHz	dB(*1)	-	1.3	2.2	
	814.24 ~ 815MHz	dB(*1)		1.4	2.4	
	845 ~ 848.76MHz	dB(*1)		1.9	2.9	
Amplitude ripple	814.24 ~ 848.76MHz	dB	-	1.2	2.2	
VSWR	Tx		-	1.6	2.0	
	ANT		-	1.5	2.0	

Attenuation:

10 ~ 494 MHz	dB	35	41	-	
494 ~ 804 MHz	dB	32	37	-	
859.24 ~ 893.76 MHz	dB	44	56	-	
1475.9 ~ 1698 MHz	dB	35	40	-	
1710 ~ 2494 MHz	dB	30	35	-	
3256 ~ 4245 MHz	dB	20	27	-	
4884 ~ 6000 MHz	dB	35	44	-	
6512 ~ 6792 MHz	dB	15	28	-	
7326 ~ 7641 MHz	dB	12	26	-	

(*1) Specification of insertion loss excludes loss that comes from the test board

ANT to Rx ($f_{T0}=876.5$ MHz)

Parameters Description		Unit	Min	Typ	Max	Remarks
Insertion Loss	859.24 ~ 893.76 MHz	dB(*1)	-	2.0	3.1	
Amplitude ripple	859.24 ~ 893.76 MHz	dB	-	1.0	2.2	
VSWR	ANT	-		1.8	2.2	
	Rx					
Attenuation:						
1 ~ 447 MHz		dB	50	75	-	
814.24 ~ 848.76 MHz		dB	45	55	-	
909 ~ 979 MHz		dB	10	22	-	
1427 ~ 2500 MHz		dB	45	50	-	
2577 ~ 6000 MHz		dB	38	47	-	
6013 ~ 6258 MHz		dB	20	44	-	

Tx to Rx

Isolation	814.24 ~ 848.76 MHz	dB	55	60	-	
	859.24 ~ 893.76 MHz	dB	52	57	-	

(*1) Specification of insertion loss excludes loss that comes from the test board.

C.Evaluation Circuit

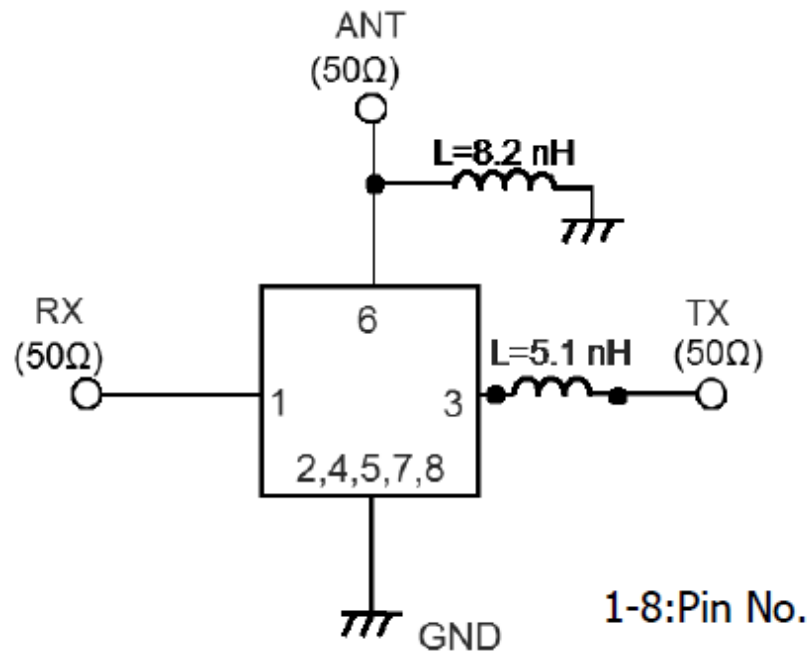

D. FREQUENCY CHARACTERISTICS:

Tx to Ant

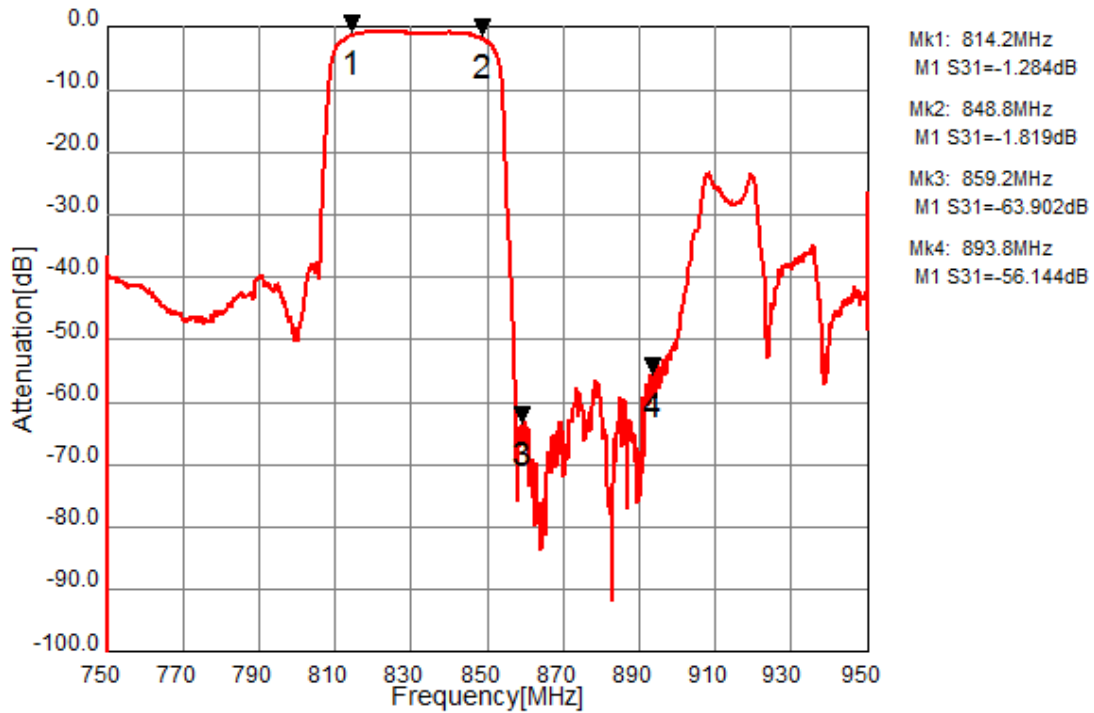

Ant to Rx

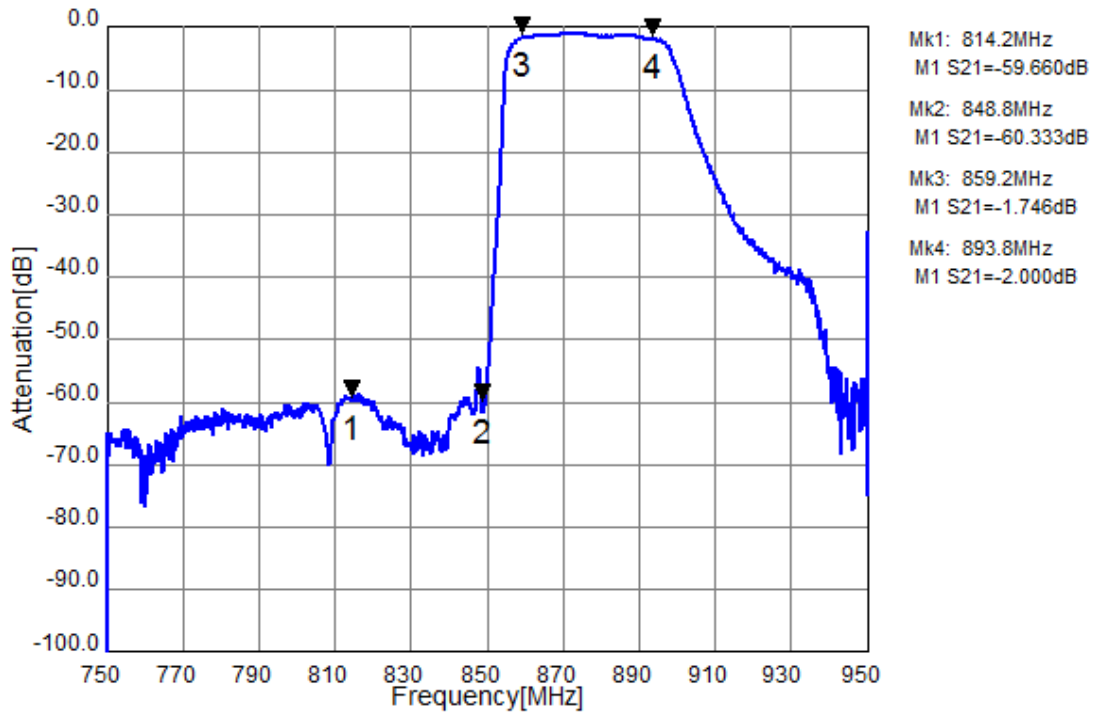

Tx to Ant, Ant to Rx

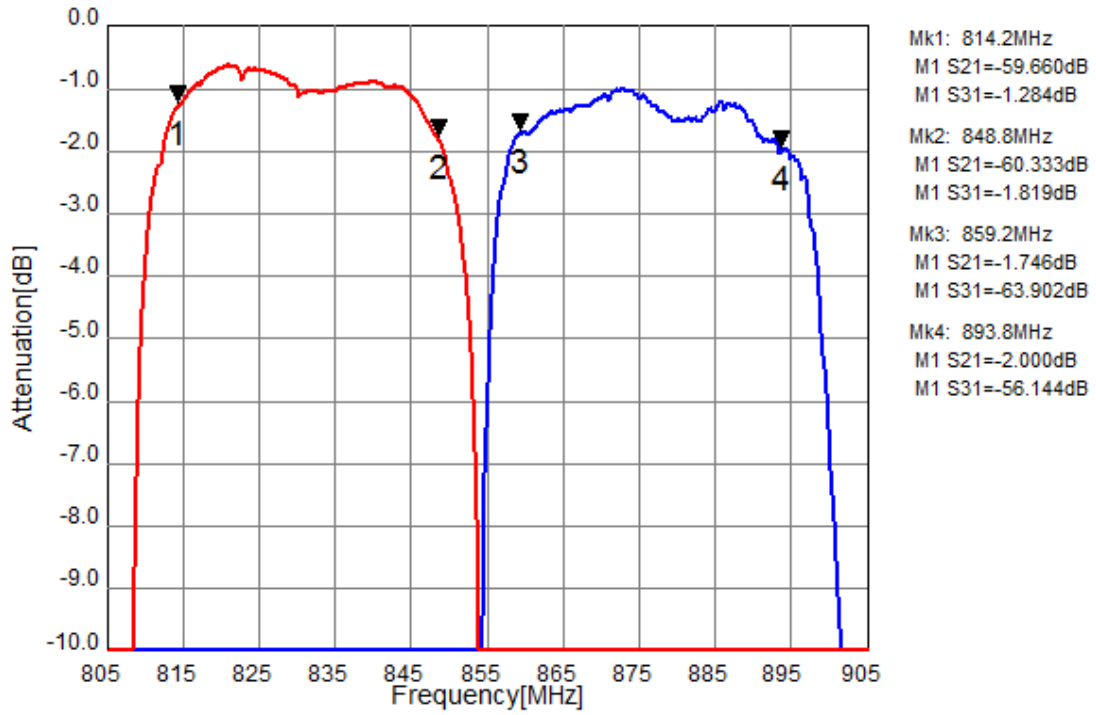

Tx to Rx Isolation

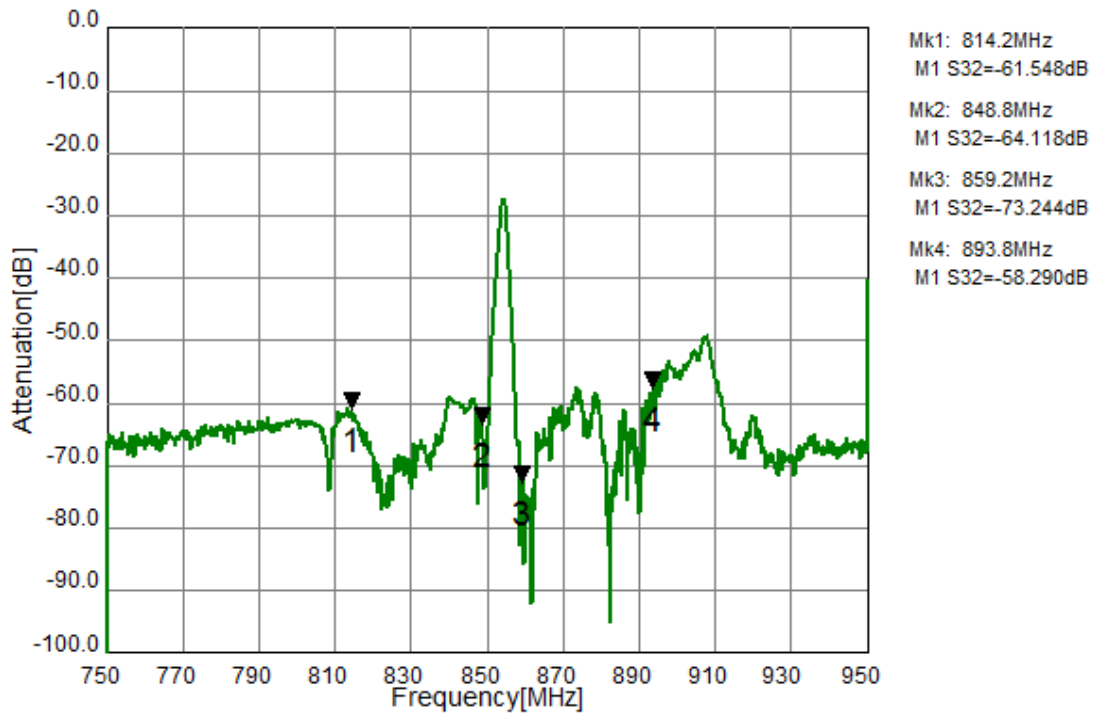

Tx Port

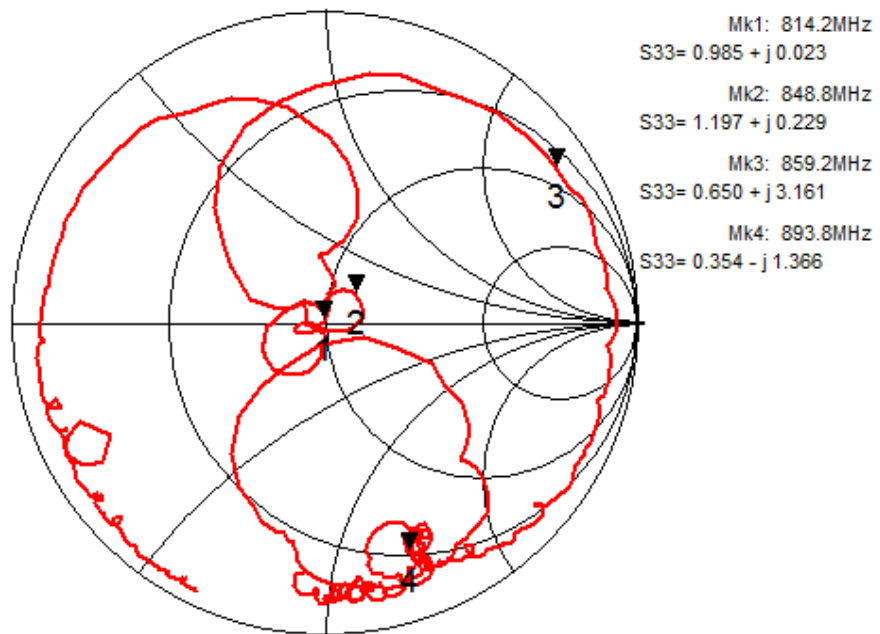
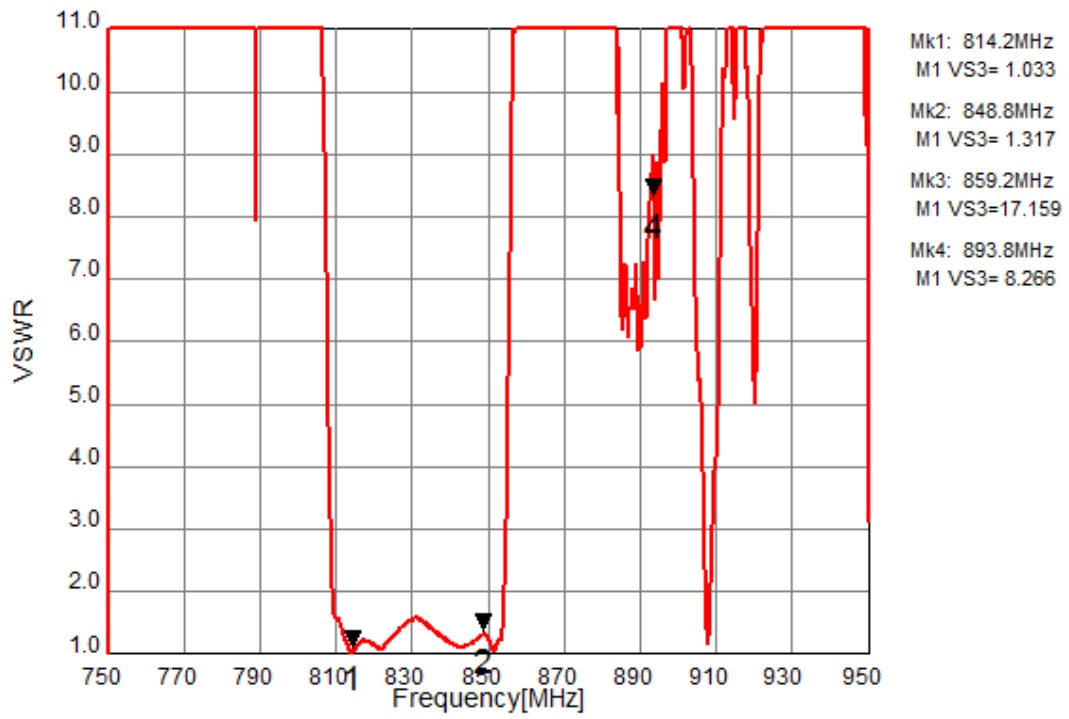

Rx Port

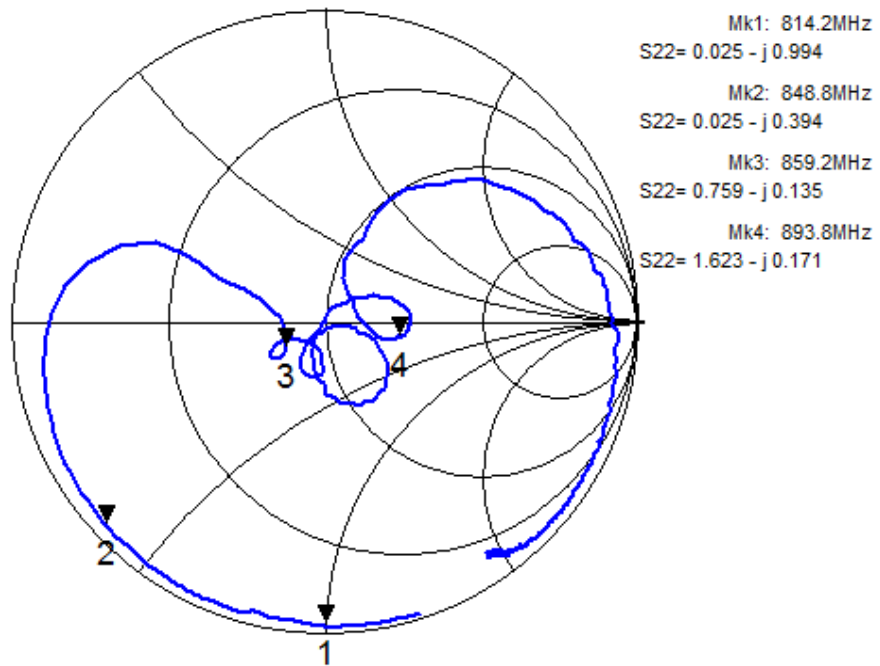
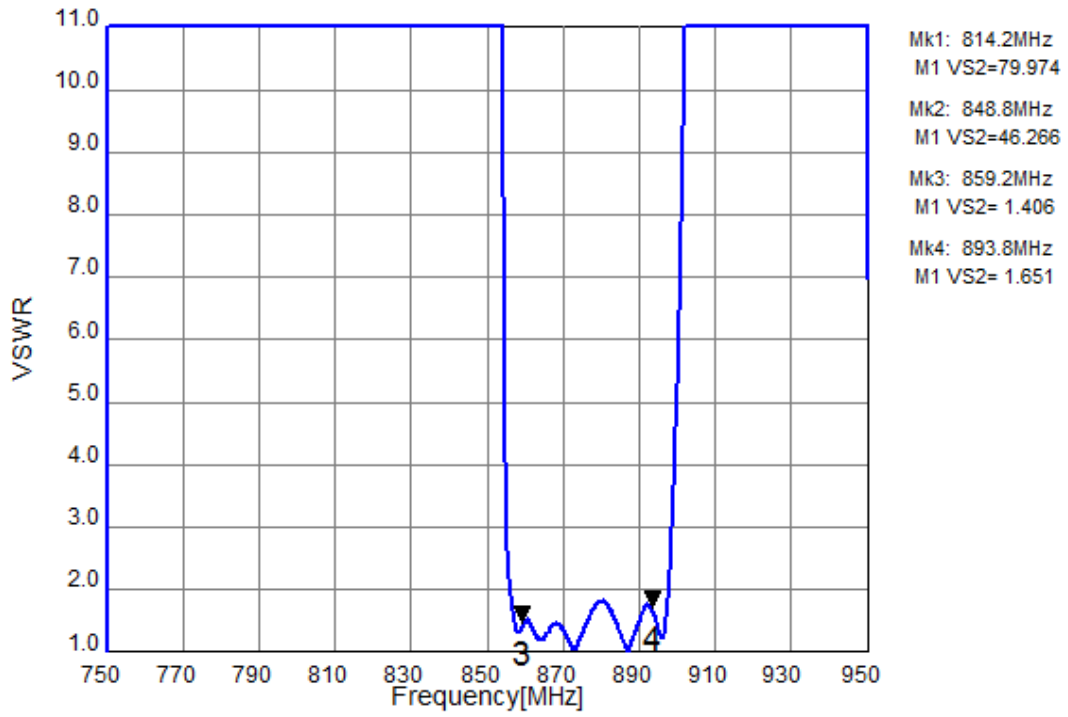

Ant Port

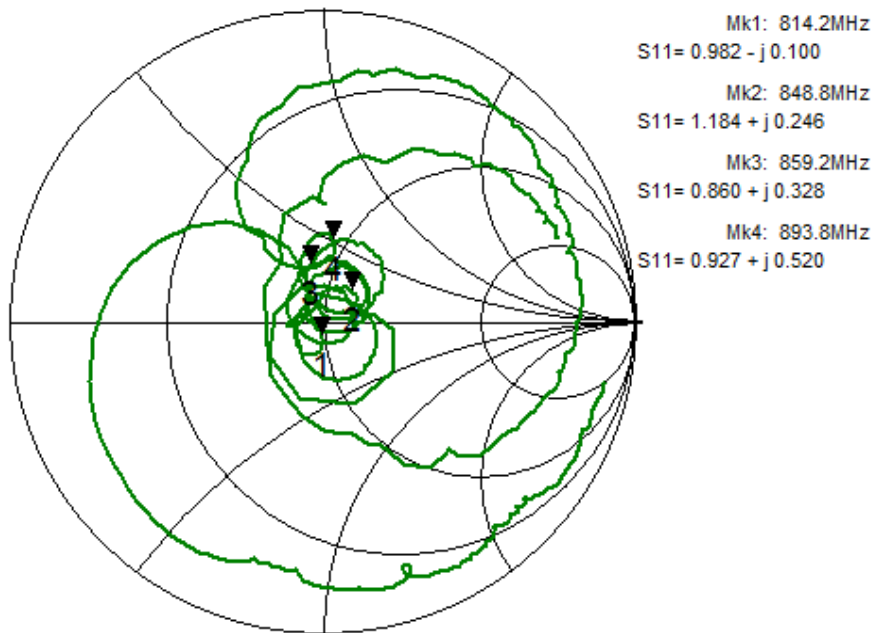
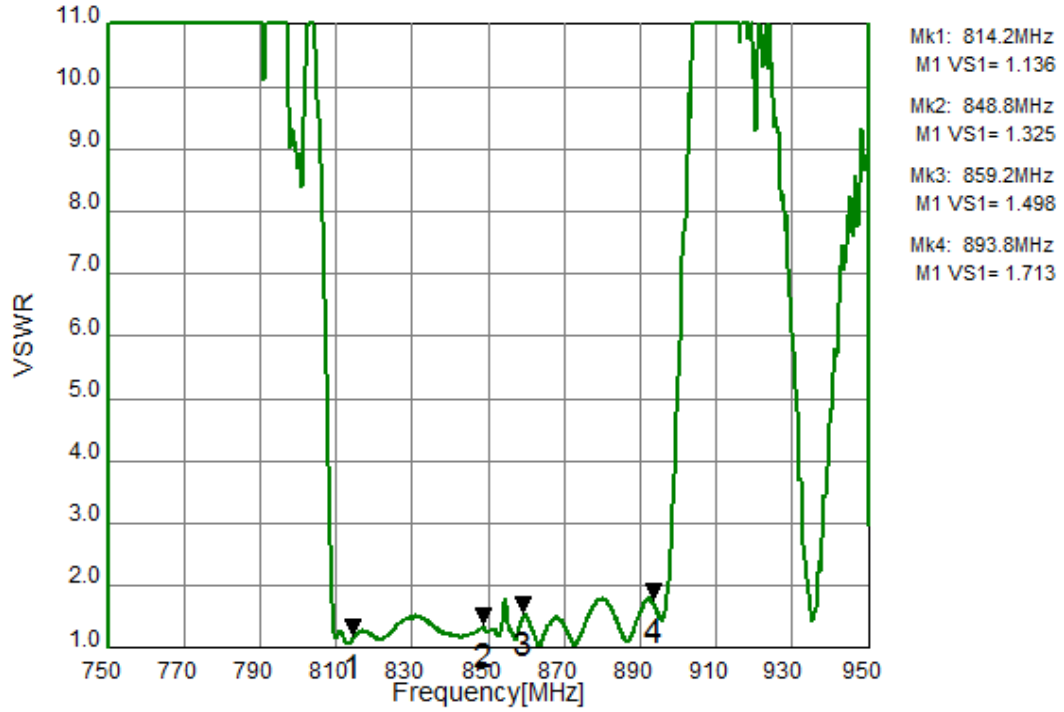

Tx to Ant (Wide Span)

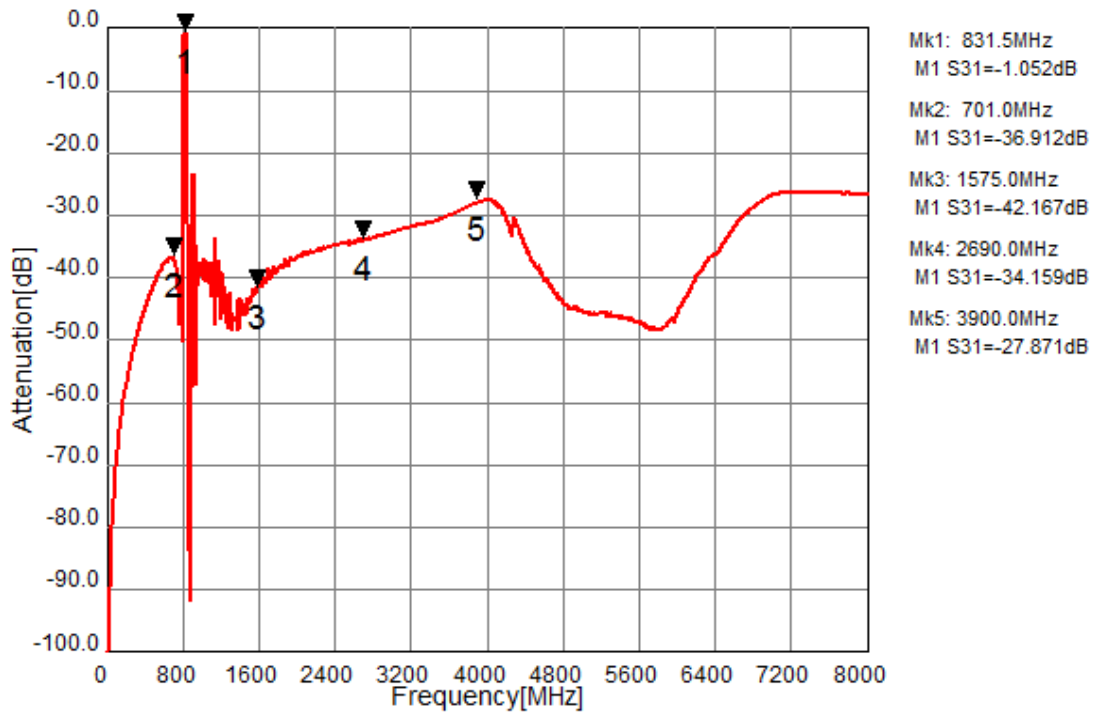

Ant to Rx (Wide Span)

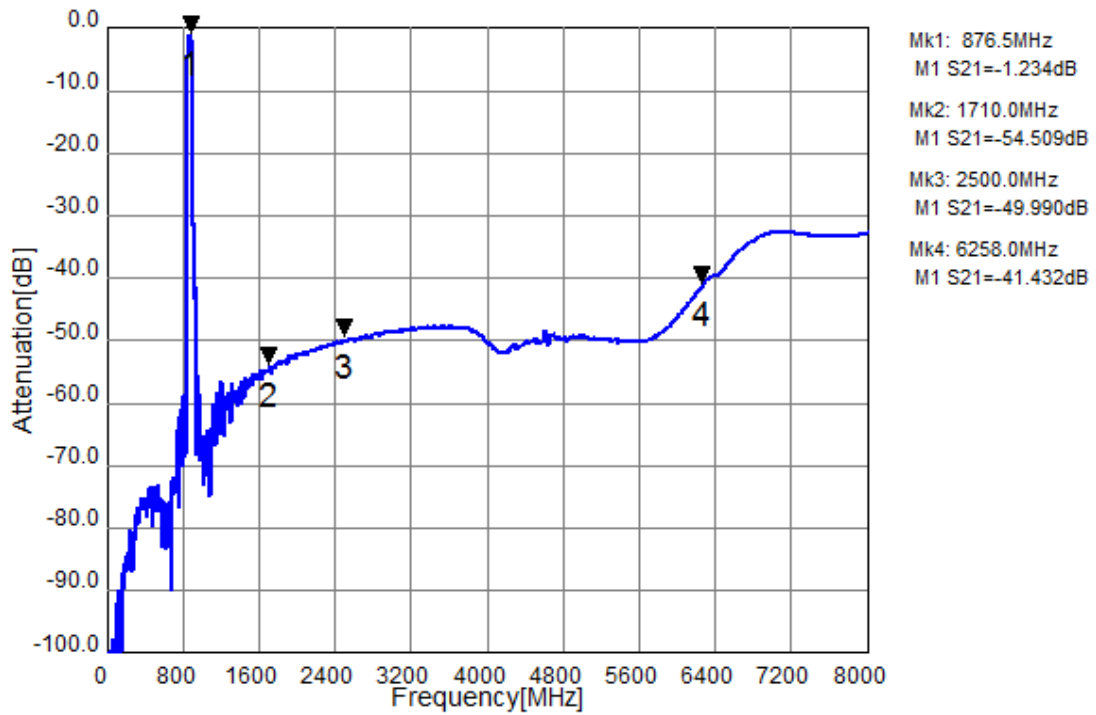

**E.OUTLINE DRAWIN:
(Mass Production)**

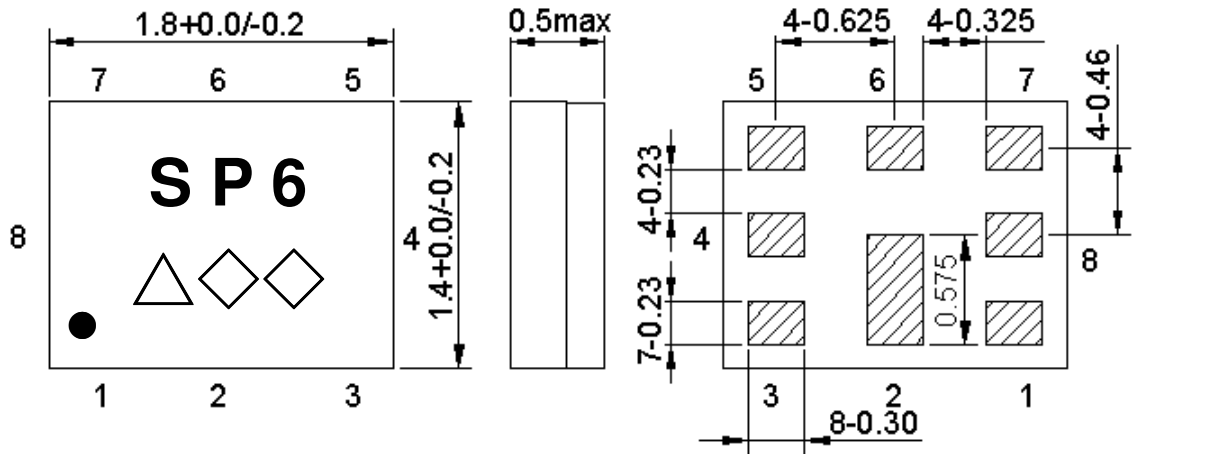

Marking name : **SP6**

△: Date code(2016 May → s ,....., 2019 Dec→m.)

◇◇: Lot Code.

Product Date Code. Follow below table.

Not Specified Tolerance : +/-0.05 mm

Coplanarity : 0.1 mm max.

1 to 8 : Pin No.

Unit : mm

Year	Jan	Feb	Mar	Apr	May	Jun	Jul	Aug	Sep	Oct	Nov	Dec
2016	n	p	q	r	s	t	u	v	w	x	y	z
2017	A	B	C	D	E	F	G	H	J	K	L	M
2018	N	P	Q	R	S	T	U	V	W	X	Y	Z
2019	a	b	c	d	e	f	g	h	j	k	l	m

Pin assignment

Pin No.	Pin name	Description
1	Rx	Receiver
2	GND	Ground
3	Tx	Transmitter
4	GND	Ground
5	GND	Ground
6	Ant	Antenna
7	GND	Ground
8	GND	Ground

Figure 1. Dimensions and Pin assignment

F . FOOTPRINT:

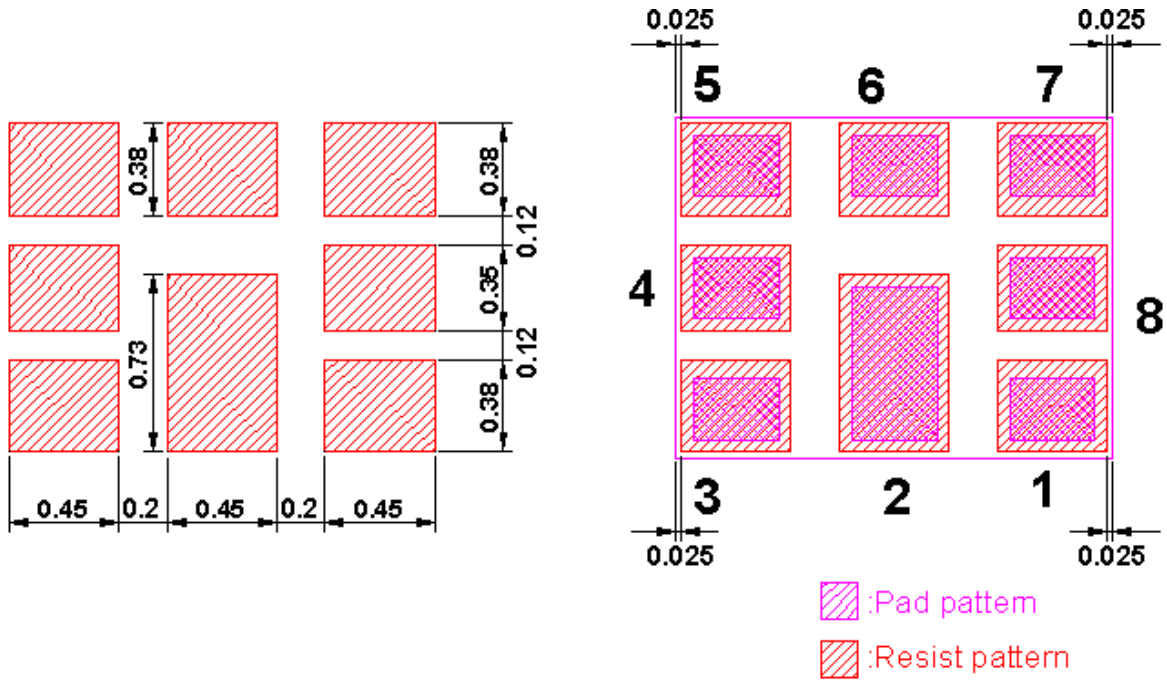

G. PACKING:

1. REEL DIMENSION

(Please refer to FR-75D10 for packing quantity)

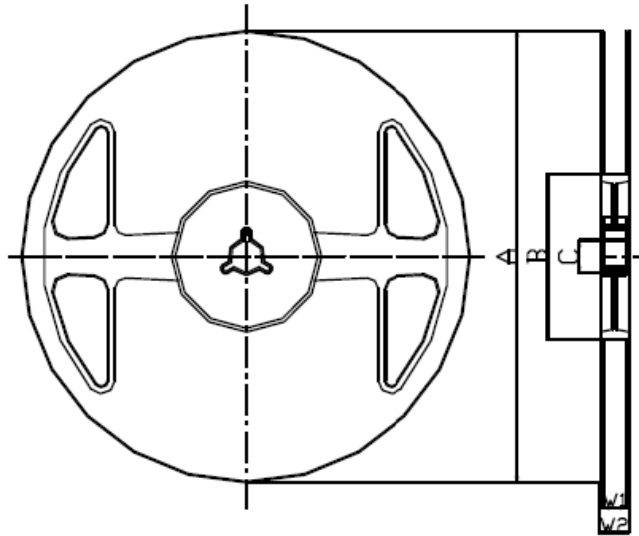

Materials of Reel

Material : Polystyrene + Carbon

Characteristics : Conforms to EIAJ-ET-7200A

Color : Black

Surface resistance (reference value) : $10^9\Omega/\text{sq Max.}$

Unit : mm

Code	Quantity	A	B	C	W1	W2
Z	3,000 pcs	$\phi 180.0 +0.0/-1.5$	$\phi 66.0 +/-0.5$	$\phi 13.0 +/-0.2$	$9.0 +1.0/-0.0$	$11.4 +/-1.0$

2. TAPE DIMENSION

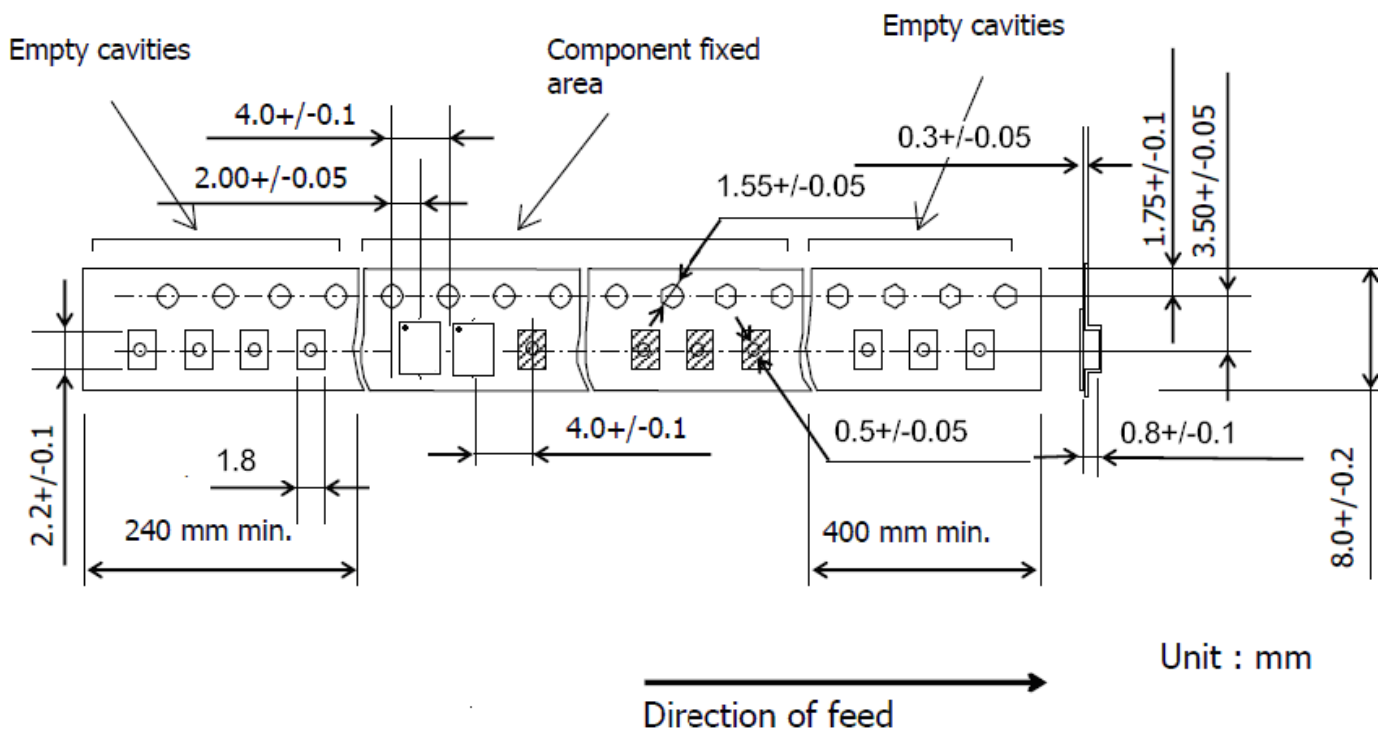

Unit : mm

H. RECOMMENDED REFLOW PROFILE :

1. Preheating shall be fixed at 150~180°C for 60~90 seconds.
2. Ascending time to preheating temperature 150°C shall be 30 seconds min.
3. Heating shall be fixed at 220°C for 50~80 seconds and at 245~260°C peak (min. 10sec).
4. Time : 2 times.

