

IEC Standard Compliant 1.85mm coaxial connectors

1.85mm Series

Compatible with 67GHz configurations



■ Features

1. IEC Standard Compliant 1.85mm coaxial connector
(IEC 61169-32)
2. Compatible with the frequency range of up to 67GHz
3. RoHS2 compliant

■ Applications

Optical transmission devices,
Measuring for data transmission,
Radio communication equipment,
Measuring instruments etc.

■ Product Specifications

Ratings	Nominal characteristic impedance	50Ω	Operating Temperature Range	-55°C to +105°C (95% RH or less)
	Rated frequency	DC to 65GHz	Storage Temperature Range	-55°C to +50°C (95% RH or less)

Items	Specifications	Conditions
1. Contact resistance	Center : Less than 4mΩ External : Less than 4mΩ	Measured at less than 100mA
2. Insulation resistance	500MΩ min.	Measured at 250V DC
3. Withstanding voltage	No flashover or breakdown	300V AC for 1 minute
4. Voltage standing wave ratio	V.S.W.R. : Less than 1.5	DC to 65GHz
5. Mating Cycles	Contact resistance at center : Less than 6mΩ External : Less than 6mΩ No broken, cracked, or loose parts	500 cycles
6. Vibration resistance	No electrical discontinuity for more than 1μs. No broken, cracked, or loose parts	Frequency : 10 to 2000Hz, half amplitude : 0.75mm, Acceleration : 196m/s ² , 12 cycles in each of 3 axis directions
7. Shock resistance	No electrical discontinuity for more than 1μs. No broken, cracked, or loose parts	Acceleration : 980m/s ² , duration : 6ms, Wave form : half-sine wave, 3 times in each of 3 directions
8. Moisture resistance of temperature/humidity cycle	Insulation resistance : More than 100MΩ (in a high humidity environment) Insulation resistance : More than 500MΩ (in a dry environment) No broken, cracked or loose parts	Left for 10 cycles (240 hours) in an environment with the temperature ranging from -10 to 65°C and the humidity ranging from 90 to 98%.
9. Temperature cycle	No broken, cracked or loose parts	Temperature : 5 cycles for a series of time periods : -55°C for 30 minutes → 3 minutes → +105°C for 30 minutes → 3 minutes
10. Salt spray	No considerable corrosion	Continuous 48 hour cycle in 5% salt water solution

*Measurement of voltage standing wave ratio (V.S.W.R.)

The specified values of the voltage standing wave ratio (V.S.W.R.) noted above, are taken with the test set up shown in the figure below:

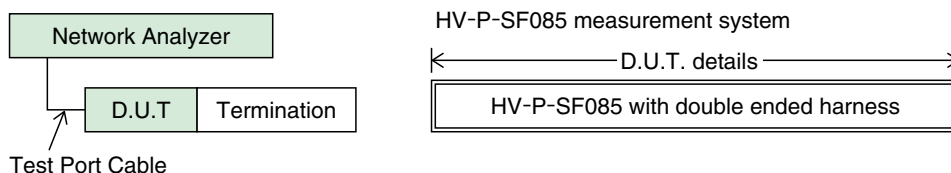

Materials / Finish

Part	Materials	Finish
Shell	Stainless steel	Passivated
Insulator	PPO / PTFE resin	—
Contact	Beryllium copper	Gold plated
Ring	Stainless steel	Gold plated

Plug

HV-P-SF085

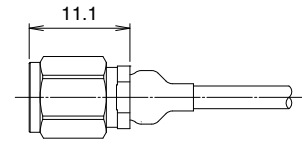

[Please place cable assembly orders per the specifications below]

Cable assembly specifications

Please specify the dimensions of 1.85mm Series cable assembly as follows : Please contact HRS representative for cable length.

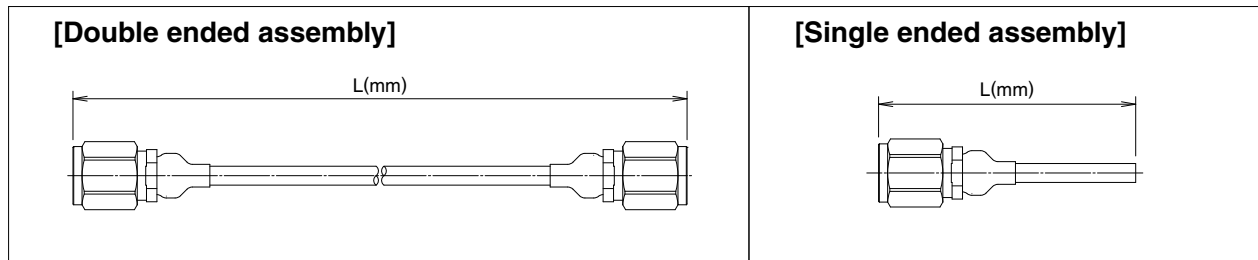

Cable harness part numbering system

Refer to the chart below when determining the product specifications from the product number.

Please select from the product numbers listed in this catalog when placing orders.

HV - [] P - SF085N 1 - A - L RS

① ② ③ ④ ⑤

① Series identifier : HV
② Harness type None : On either end 2 : On both ends
③ Cable type SF085N : 0.085-inch, semi-flexible cable
④ Cable color None : No jacket 1 : Blue
⑤ Overall length L (mm) : Length L is expressed by the unit of mm.

■ Nonreflective terminator
■ Product Specifications

Ratings	Nominal characteristic impedance	50Ω	Operating Temperature Range	-10°C to +65°C
	Rated frequency	DC to 67GHz		
	Power	0.5W CW (+65°C)	Operating relative humidity	95% RH or less

■ Materials / Finish

Part	Materials	Finish
Shell	Stainless steel	Passivate
Insulator	PTFE	—
Male contact	Brass	Gold plated
Coupling	Stainless steel	Passivate
Resistive element	Metal film	—

■ Product Number Structure

HV - TM P (40)

① ② ③

① Series identifier	HV
② TM	Non-reflective terminator
③ Connector type	P : Plug type

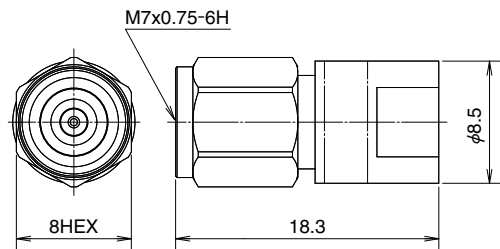

Part No.	HRS No.	Voltage standing wave ratio (V.S.W.R.)(max)	
		DC~50GHz	50~67GHz
HV-TMP(40)	353-0146-6 40	1.3	1.4

◆ Frequency characteristics (TYPICAL)

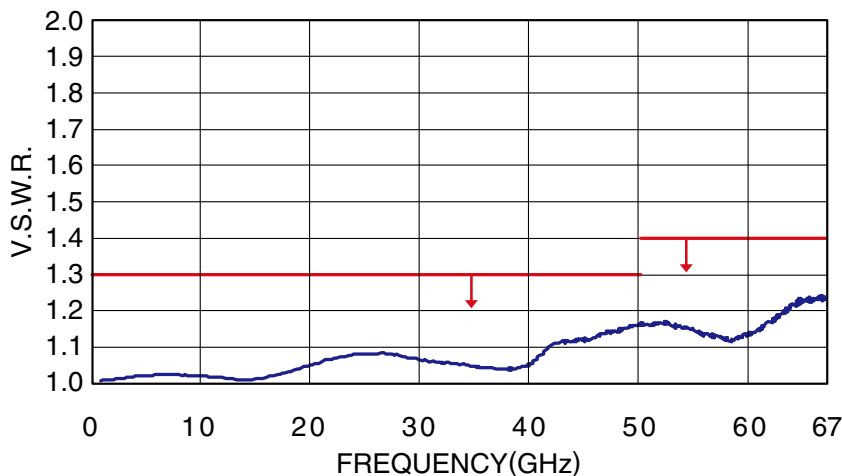

■ Attenuator ■ Product Specifications

Ratings	Nominal characteristic impedance	50Ω	Operating Temperature Range	-10°C to +65°C
	Rated frequency	DC to 67GHz		
	Power	1W CW (+65°C)	Operating relative humidity	95% RH or less

■ Materials / Finish

Part	Materials	Finish
Shell	Stainless steel	Passivate
Insulator	PTFE resin	—
Male contact	Brass	Gold plated
Female contact	Beryllium copper	Gold plated
Coupling	Stainless steel	Passivate
Resistive element	Metal film	—



■ Product Number Structure

HV - AT (※※) - PJ

①	②	③	④
① Series identifier	HV		
② AT	Attenuator		
③ Attenuation	(Ex.) (0) : 0dB (through) (3) : 3dB (10) : 10dB		
④ Connector type	PJ : Plug Jack		

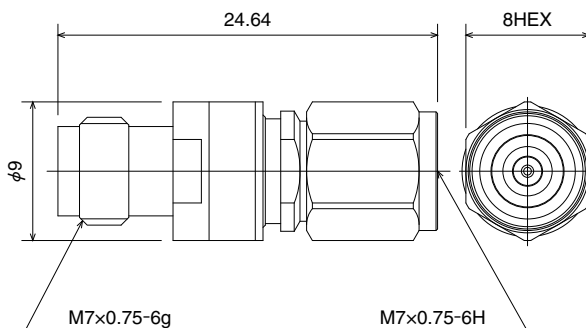

Part No.	HRS No.	Attenuation (dB)				Voltage standing wave ratio (V.S.W.R.)(max)					
		DC~18GHz	18~26.5GHz	26.5~40GHz	40~67GHz	DC~18GHz	18~26.5GHz	26.5~40GHz	40~67GHz		
HV-AT(0)-PJ	354-0244-1	0 ^{+0.4} ₀	0 ^{+0.5} ₀	0 ^{+0.8} ₀	0 ^{+1.0} ₀	1.4		1.55			
HV-AT(1)-PJ	354-0288-0	1 ^{+0.7} _{-0.3}	1 ^{+0.8} _{-0.3}	1 ^{+1.0} _{-0.3}	1 ^{+1.6} _{-0.3}	1.35	1.4				
HV-AT(2)-PJ	354-0289-0	2 ^{+0.7} _{-0.3}	2 ^{+0.8} _{-0.3}	2 ^{+1.0} _{-0.3}	2 ^{+1.6} _{-0.3}						
HV-AT(3)-PJ	354-0245-4	3 ^{+0.6} _{-0.4}	3 ^{+0.7} _{-0.4}	3 ^{+0.9} _{-0.4}	3 ^{+1.5} _{-0.4}	1.4				1.6	
HV-AT(4)-PJ	354-0300-0	4 ^{+0.6} _{-0.4}	4 ^{+0.7} _{-0.4}	4 ^{+0.9} _{-0.4}	4 ^{+1.6} _{-0.4}						
HV-AT(5)-PJ	354-0301-0	5 ^{+0.7} _{-0.4}	5 ^{+0.8} _{-0.4}	5 ^{+1.0} _{-0.4}	5 ^{+1.8} _{-0.4}						
HV-AT(6)-PJ	354-0246-7	6 ^{+0.7} _{-0.3}	6 ^{+0.8} _{-0.3}	6 ^{+0.9} _{-0.3}	6 ^{+1.7} _{-0.3}						
HV-AT(7)-PJ	354-0302-0	7 ^{+0.9} _{-0.4}	7 ^{+1.0} _{-0.4}	7 ^{+1.2} _{-0.4}	7 ^{+2.0} _{-0.4}						
HV-AT(8)-PJ	354-0303-0	8 ^{+0.9} _{-0.5}	8 ^{+1.0} _{-0.5}	8 ^{+1.2} _{-0.5}	8 ^{+1.8} _{-0.5}						
HV-AT(9)-PJ	354-0304-0	9 ^{+0.9} _{-0.5}	9 ^{+1.0} _{-0.5}	9 ^{+1.2} _{-0.5}	9 ^{+1.8} _{-0.5}						
HV-AT(10)-PJ	354-0247-0	10±0.7	10 ^{+0.8} _{-0.7}	10 ^{+1.0} _{-0.7}	10 ^{+2.1} _{-0.7}						
HV-AT(20)-PJ	354-0248-2	20±1.0	20 ^{+1.2} _{-1.0}	20 ^{+1.4} _{-1.0}	20 ^{+1.6} _{-1.0}						

◆ Frequency characteristics (TYPICAL)

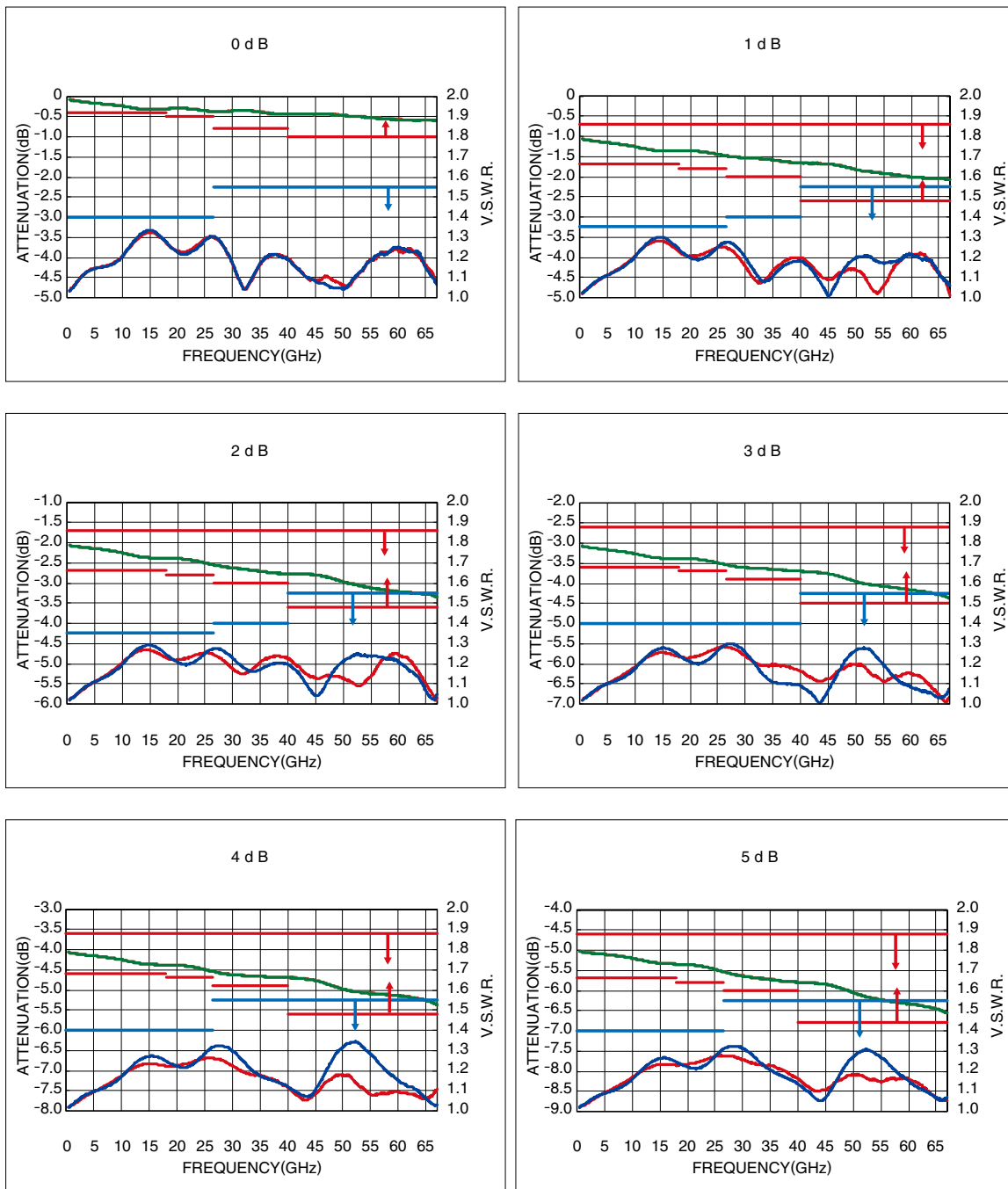

Jul.1.2021 Copyright 2021 HIROSE ELECTRIC CO., LTD. All Rights Reserved.

◆ Frequency characteristics (TYPICAL)

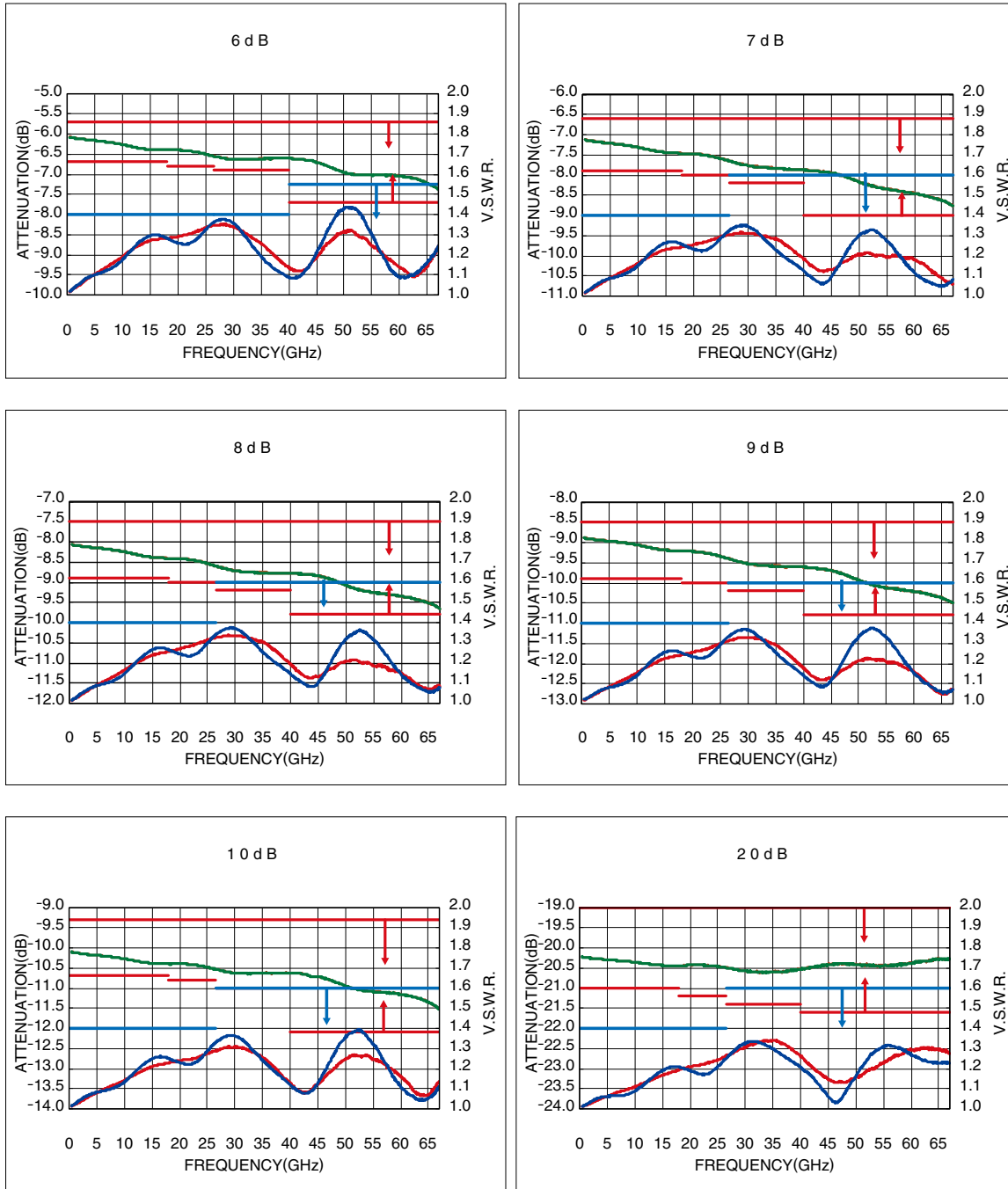

◆ Precautions

1. The center pin contact has the diameter of 0.511mm. Exercise caution when handling the attenuator. When mating the attenuator with the corresponding connector rotate the hex part only.
2. When mating the attenuator pay attention to dirt on a shell interface. When becoming dirty, please clean with alcohol wipe.