



PARA LIGHT ELECTRONICS CO., LTD.
4F, No.1, Lane 93, Chien Yi Road, Chung Ho City, Taipei, Taiwan.
Tel: 886-2-2225-3733 Fax: 886-2-2225-4800
E-mail: para@para.com.tw <http://www.para.com.tw>

DATA SHEET

PART NO.: L-C19F1RGBCT-CC

REV: A / 1

CUSTOMER'S APPROVAL: _____

DCC: _____

DRAWING NO.: DS-79-15-0002

DATE: 2017-1-12

PAGE

1 of 15



SURFACE MOUNT DEVICE LED

Part No.: L-C19F1RGBCT-CC

REV:A / 1

● PACKAGE OUTLINE DIMENSIONS

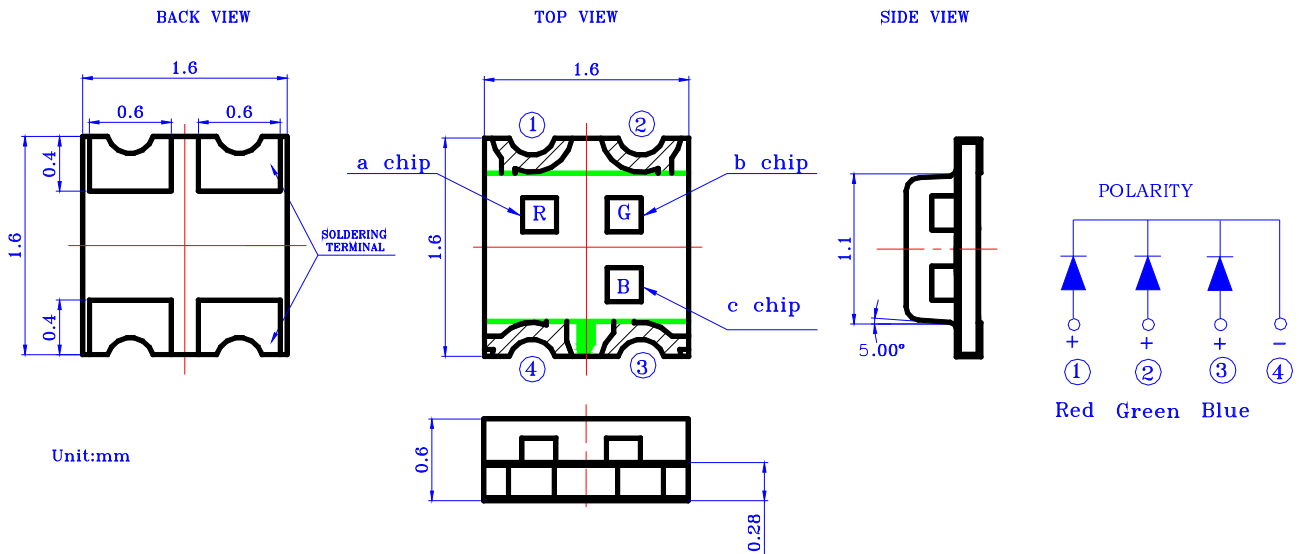

Notes:

1. a chip: Red; b chip: Green; c chip: Blue
2. All dimensions are in millimeters.
3. Tolerance is $\pm 0.1\text{mm}$ (.004") unless otherwise noted.

● Features

- * Three color, top view, wide view angle Chip LED.
- * Package in 8mm tape on 7" diameter reels.
- * Compatible with automatic Pick & Place equipment.
- * Compatible with Reflow soldering and Wave soldering processes.
- * EIA STD package.
- * I.C. compatible.
- * Pb free product.



SURFACE MOUNT DEVICE LED

Part No.: L-C19F1RGBCT-CC

REV:A / 1

● Chip Materials

Chip	Light Color	Dice Material	Lens Color
a	R: Red	AlInGap	Water Clear
b	G: Green	InGaN	
C	B: Blue	InGaN	

● Absolute Maximum Ratings (Ta=25°C)

SYMBOL	PARAMETER	Rating			UNIT
		R	G	B	
PD	Power Dissipation	75	100	100	mW
VR	Reverse Voltage	5			V
IF	Continuous Forward Current	25	25	25	mA
IPF	Peak Forward Current	80	100	100	mA
ESD	Electrostatic Discharge Threshold (HBM) ^{Note A}	2000	1000	1000	V
Topr	Operating Temperature Range	-40 ~ +85			°C
Tstg	Storage Temperature Range	-40 ~ +85			°C

Note A:

HBM: Human Body Model. Seller gives no other assurances regarding the ability of to withstand ESD



SURFACE MOUNT DEVICE LED

Part No.: L-C19F1RGBCT-CC

REV:A / 1

● Electro-Optical Characteristics (Ta=25°C)

SYMBOL		PARAMETER	TEST	MIN.	TYP.	MAX.	UNIT
VF	R	Forward Voltage	IF = 20mA	1.5		2.4	V
	G			3.0		3.5	
	B			2.8		3.4	
IV	R	Luminous Intensity	IF = 20mA	280		450	mcd
	G			280		710	
	B			71		180	
λD	R	Dominant Wavelength	IF = 20mA		623		nm
	G				525		
	B				470		
Δλ	R	Spectral Line Half-Width	IF = 20mA		17		nm
	G				15		
	B				25		
λp	R	Peak Emission Wavelength	IF = 20mA		630		nm
	G				520		
	B				468		
2θ1/2		Half Intensity Angle	IF = 20mA		130		deg
IR	R	Reverse Current	VR = 5V			10	μA
	G					50	
	B					50	

Notes:

1. Luminous intensity is measured with a light sensor and filter combination that proximities the CIE eye-response curve.
2. θ 1/2 is the off-axis angle at which the luminous intensity is half the axial luminous intensity.
3. The dominant wavelength λ d is derived from the CIE chromaticity diagram and represents the single wavelength which defines the color of the device.
4. Caution in ESD :
Static Electricity and surge damages the LED. It is recommended use a wrist band or anti-electrostatic glove when handling the LED. All devices, equipment and machinery must be properly grounded.
5. Major standard testing equipment by “Instrument System” Model : CAS140B Compact Array Spectrometer and “KEITHLEY” Source Meter Model : 2400.



SURFACE MOUNT DEVICE LED

Part No.: L-C19F1RGBCT-CC

REV:A / 1

● Red Typical Electro-Optical Characteristics Curves

(25°C Ambient Temperature Unless Otherwise Noted)

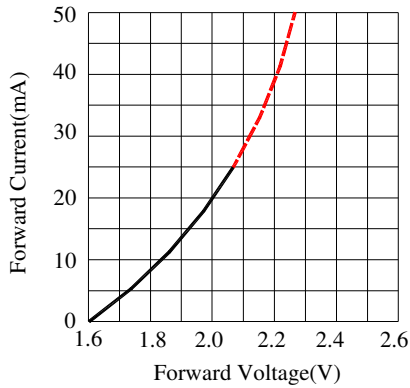

Fig.2 Forward Current vs. Forward Voltage

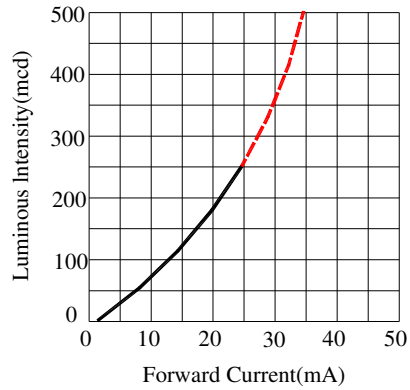

Fig.3 Luminous Intensity vs. Forward Current

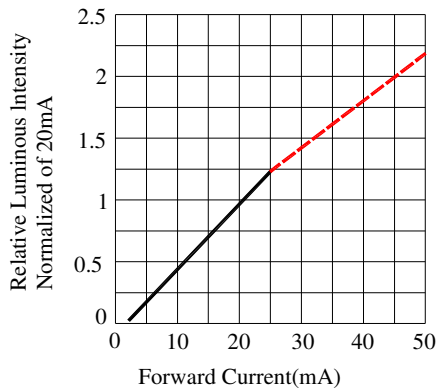

Fig.4 Relative Luminous Intensity vs. Forward Current

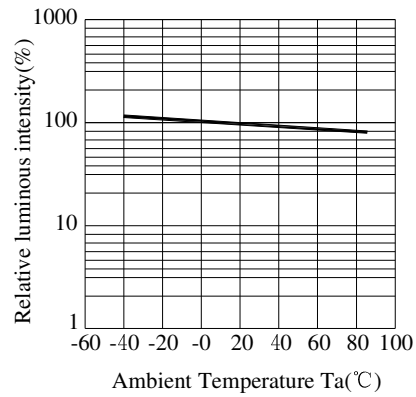

Fig.5 Luminous Intensity vs. Ambient Temperature

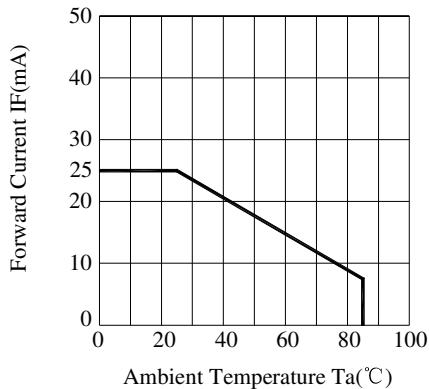

Fig.6 Forward Current Derating Curve

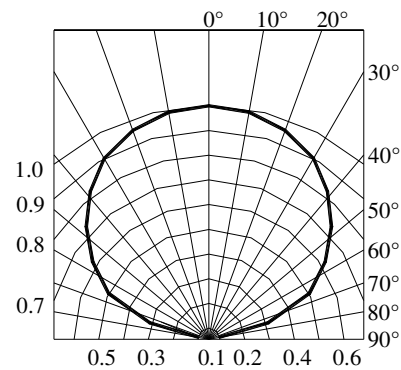

Fig.7 Relative Intensity vs. Angle



SURFACE MOUNT DEVICE LED

Part No.: L-C19F1RGBCT-CC

REV:A / 1

● Green Typical Electro-Optical Characteristics Curves

(25°C Ambient Temperature Unless Otherwise Noted)

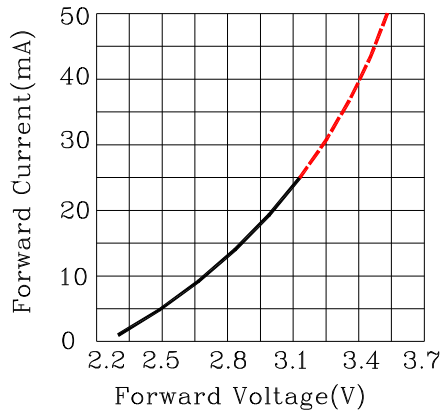

Fig.2 Forward Current vs.Forward Voltage

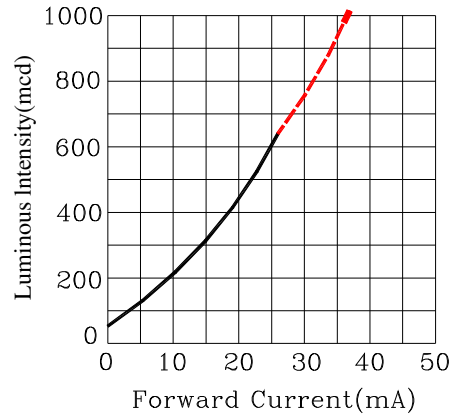

Fig.3 Luminous Intensity vs.Forward Current

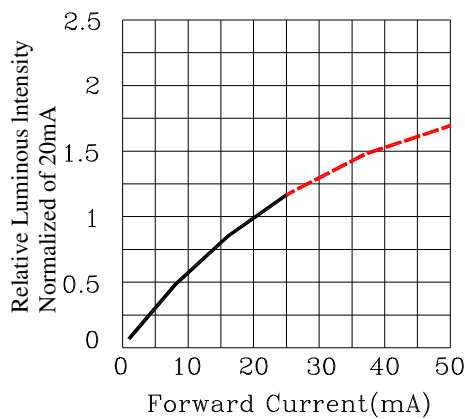

Fig.4 Relative Luminous Intensity vs.Forward Current

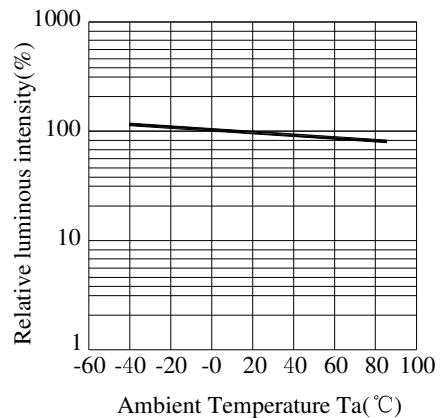

Fig.5 Luminous Intensity vs.Ambient Temperature

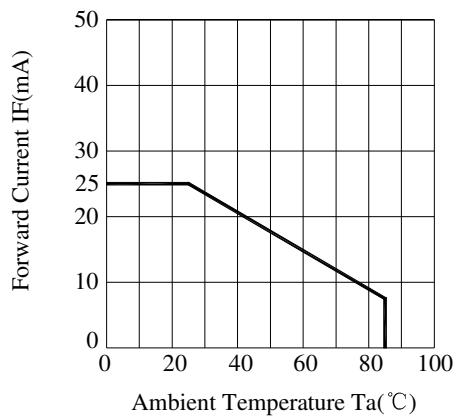

Fig.6 Forward Current Derating Curve

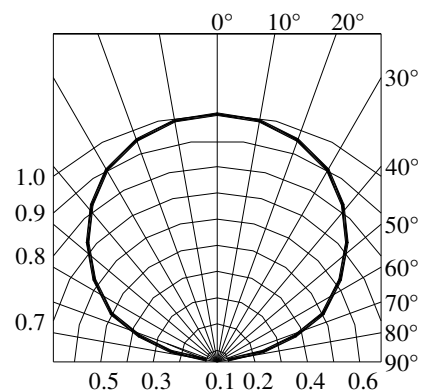

Fig.7 Relative Intensity vs.Angle



SURFACE MOUNT DEVICE LED

Part No.: L-C19F1RGBCT-CC

REV:A / 1

● Blue Typical Electro-Optical Characteristics Curves

(25°C Ambient Temperature Unless Otherwise Noted)

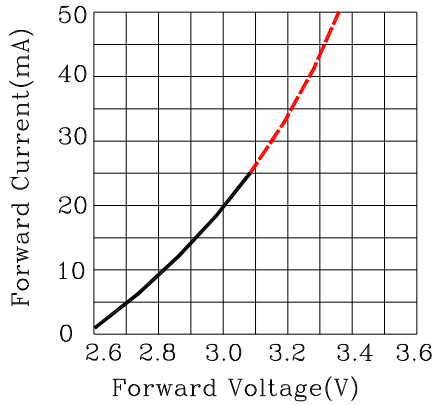

Fig.2 Forward Current vs.Forward Voltage

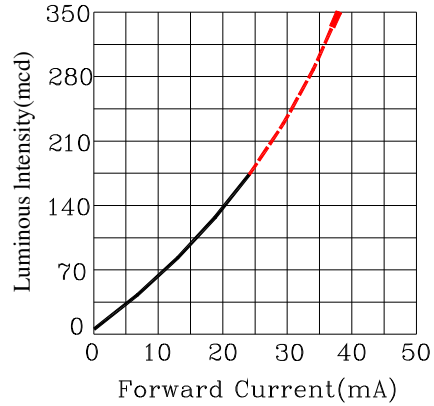

Fig.3 Luminous Intensity vs.Forward Current

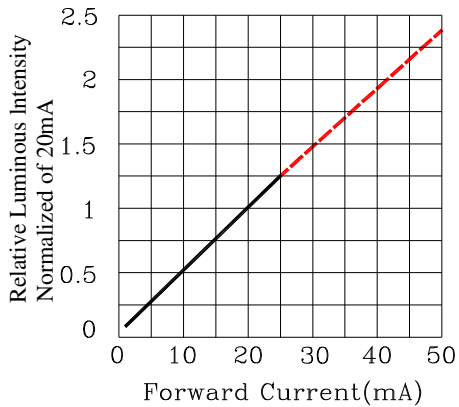

Fig.4 Relative Luminous Intensity vs.Forward Current

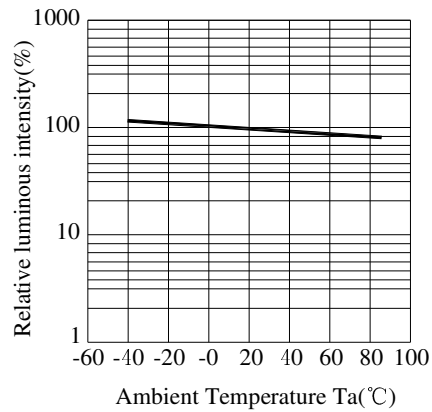

Fig.5 Luminous Intensity vs.Ambient Temperature

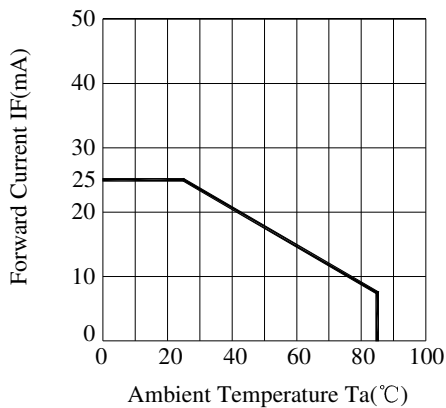

Fig.6 Forward Current Derating Curve

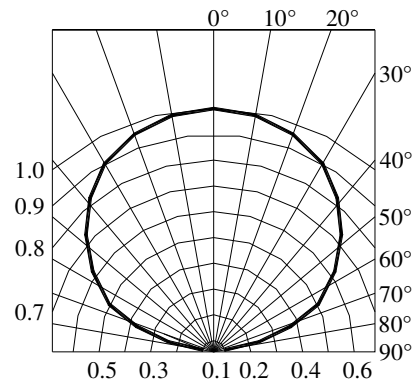

Fig.7 Relative Intensity vs.Angle



SURFACE MOUNT DEVICE LED

Part No.: L-C19F1RGBCT-CC

REV:A / 1

● Label Explanation



ITEM CODE: PARRA LIGHT

PART NO: L-C19F1RGBCT-CC

IV --- Luminous Intensity Code

LOT NO:	<u>EM</u>	<u>S</u>	<u>L</u>	<u>12</u>	<u>09</u>	<u>0110</u>
	A	B	C	D	E	F

A---EM: Emos Code

B---S:SMD

L---Local

D---Year

E---Month

F---SPEC.

PACKING QUANTITY OF BAG :

3000pcs for 150、170、110、155、115 series

4000pcs for 191 series

5000pcs for 192 series

DATE CODE:	<u>2012</u>	<u>09</u>	<u>10</u>
	G	H	I

G--- Year

H--- Month

I--- Day



SURFACE MOUNT DEVICE LED

Part No.: L-C19F1RGBCT-CC

REV:A / 1

● Typical Electro-Optical Characteristics Curves

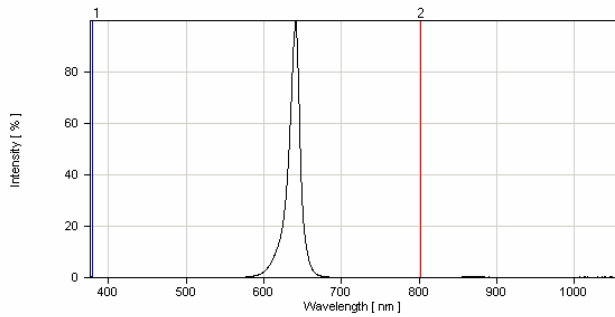

Fig.1 Red Relative Intensity vs. Wavelength

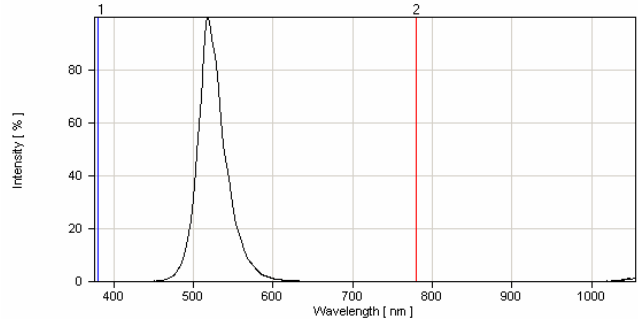

Fig.1 Green Relative Intensity vs. Wavelength

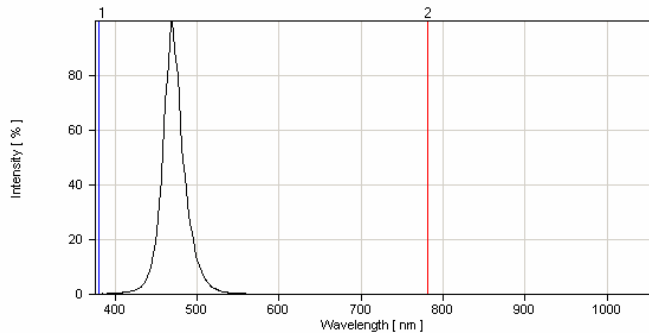
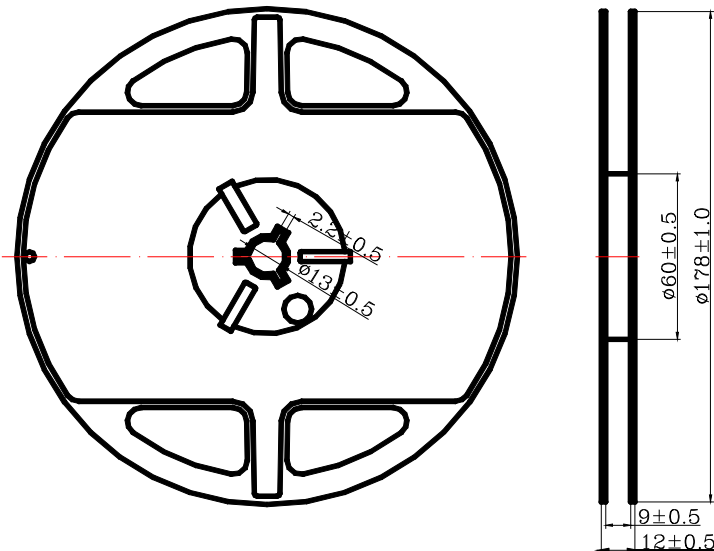

Fig.1 Blue Relative Intensity vs. Wavelength

● Reel Dimensions



Notes:

1. Taping Quantity: 3000pcs
2. The tolerances unless mentioned is $\pm 0.1\text{mm}$, Angle $\pm 0.5^\circ$, Unit: mm.



SURFACE MOUNT DEVICE LED

Part No.: L-C19F1RGBCT-CC

REV:A / 1

● Package Dimensions Of Tape And Reel

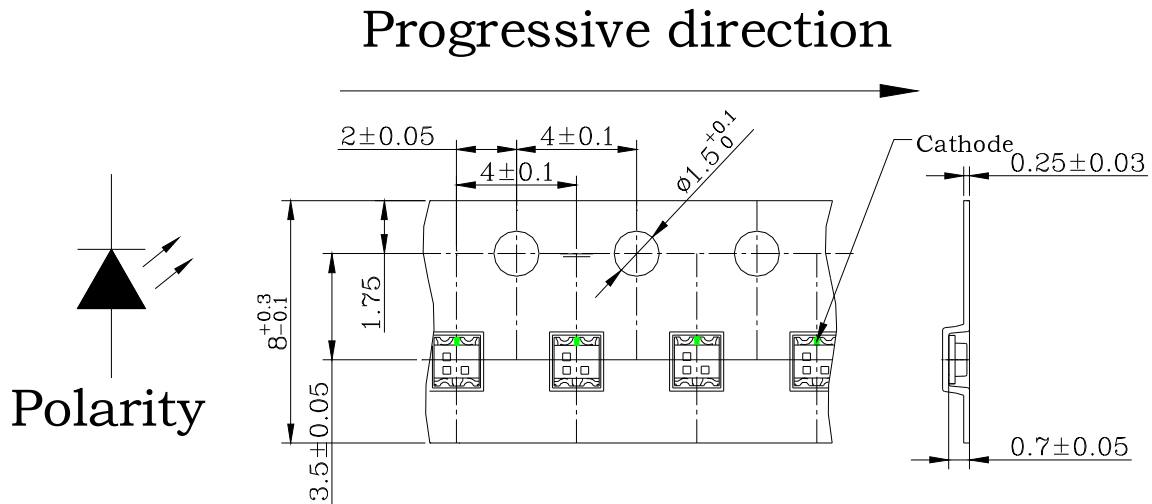

Notes: All dimensions are in millimeters.

Moisture Resistant Packaging

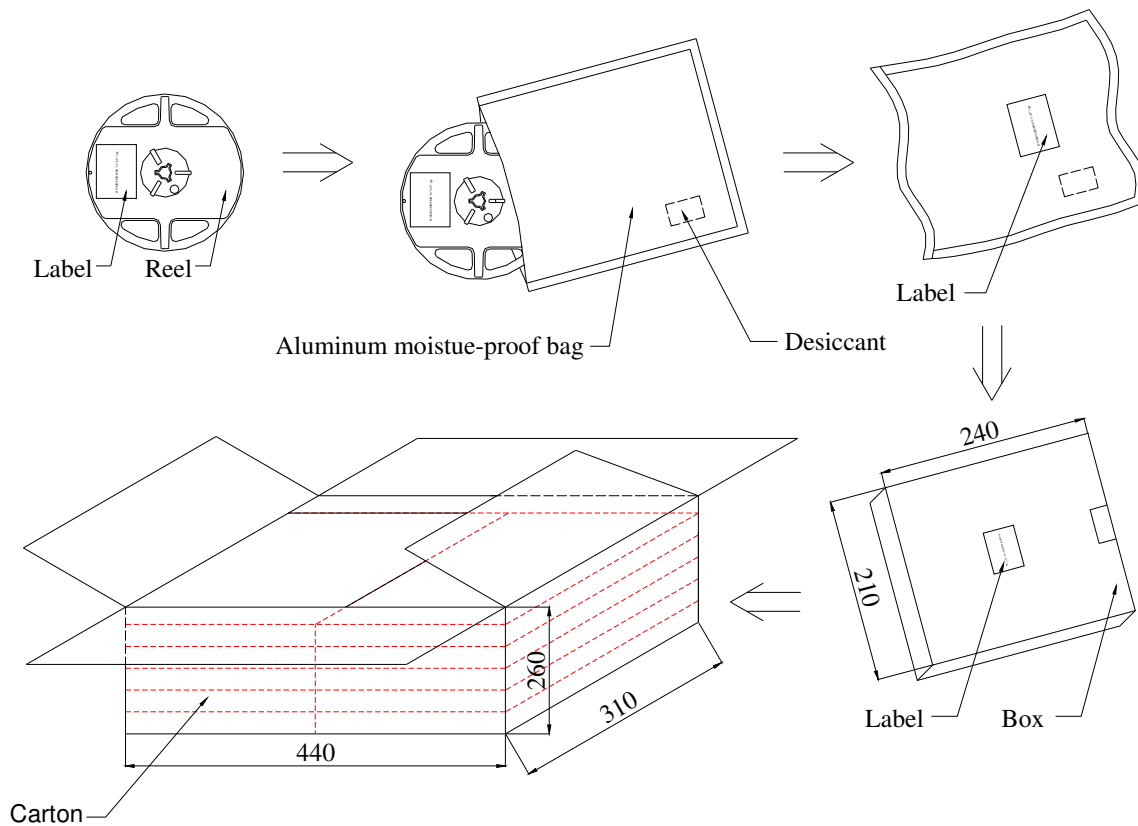

Notes : One reel in a bag, six bag in a inner box, six inner boxes in a carton. Unit : mm



SURFACE MOUNT DEVICE LED

Part No.: L-C19F1RGBCT-CC

REV:A / 1

● Cleaning

- * If cleaning is required, use the following solutions for less than 1 minute and less than 40°C.
- * Appropriate chemicals: Ethyl alcohol and isopropyl alcohol.
- * Effect of ultrasonic cleaning on the LED resin body differs depending on such factors as the oscillator output, size of PCB and LED mounting method. The use of ultrasonic cleaning should be enforced at proper output after confirming there is no problem.

● Suggest Soldering Pad Dimensions

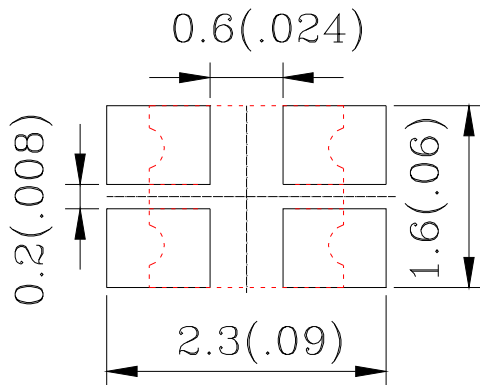

↑
↓
Direction of PWB camber
and go to reflow furnace



SURFACE MOUNT DEVICE LED

Part No.: L-C19F1RGBCT-CC

REV:A / 1

● Suggest Sn/Pb IR Reflow Soldering Profile Condition:

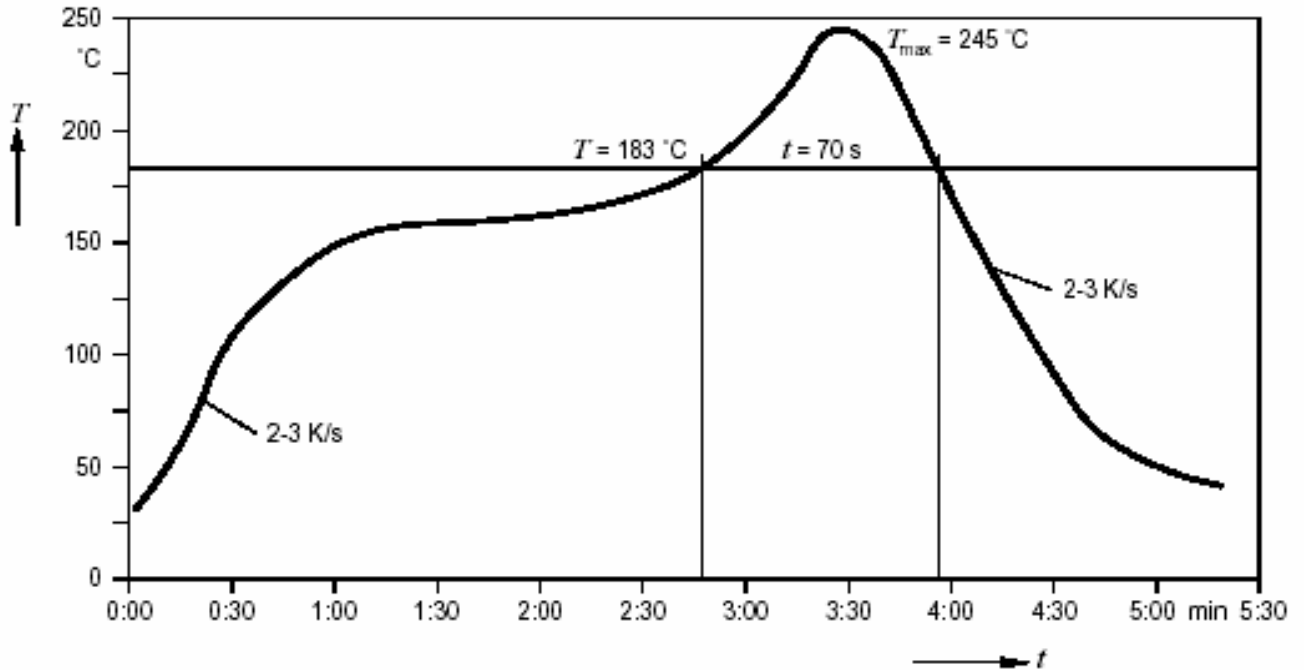

● Suggest Pb-Free IR Reflow Soldering Profile Condition:

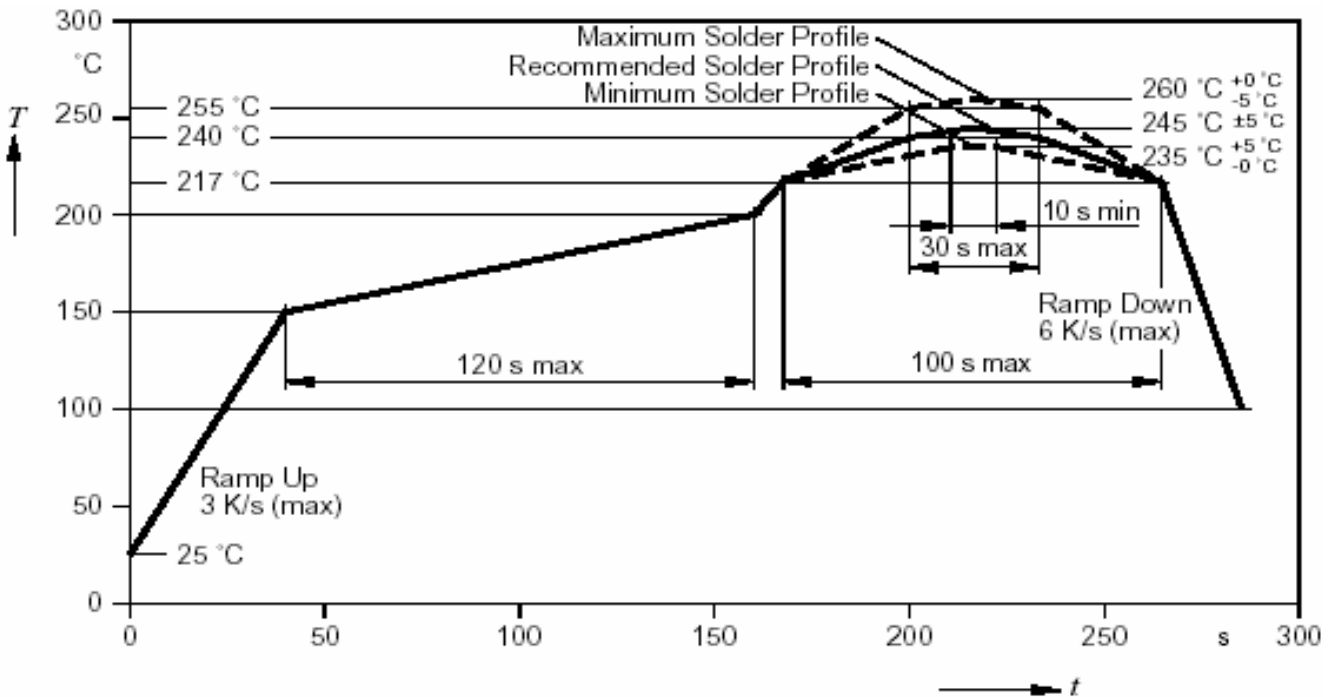



SURFACE MOUNT DEVICE LED

Part No.: L-C19F1RGBCT-CC

REV:A / 1

● Bin Code List

Luminous Intensity (IV), Unit: mcd@20mA

Red (a chip)			Green (b chip)			Blue (c chip)		
Bin Code	Min	Max	Bin Code	Min	Max	Bin Code	Min	Max
T	280	450	T	280	450	Q	71	112
			U	450	710	R	112	180

Tolerance of each bin are $\pm 15\%$

Dominant Wavelength (Hue), Unit: nm@20mA

Green (b chip)			Blue (c chip)		
Bin Code	Min	Max	Bin Code	Min	Max
AP	520	525	AC	465	470
AQ	525	530	AD	470	475

Tolerance of each bin are $\pm 1\text{nm}$

CAUTIONS

1.Application Limitation:

The LED's described here are intended to be used for ordinary electronic equipment (such as office equipment, communication equipment and household application). Consult PARA's sales in advance for information on application in which exceptional quality and reliability are required, particularly when the failure or malfunction of the LED's may directly jeopardize life or health (such as airplanes, automobiles, traffic control equipment, life support system and safety devices).

2.Storage:

Do not open moisture proof bag before the products are ready to use.

Before opening the package: The LEDs should be kept at 30°C or less and 90%RH or less.

After opening the package: The LED's floor life is 1 year under 30°C or less and 60% RH or less. If unused LEDs remain, it should be stored in moisture proof packages.

If the moisture absorbent material (silica gel) has faded away or the LEDs have exceeded the storage time, baking treatment should be performed using the following conditions.

Baking treatment: 60 \pm 5°C for 24 hours



SURFACE MOUNT DEVICE LED

Part No.: L-C19F1RGBCT-CC

REV:A / 1

3. Soldering

Do not apply any stress to the lead frame during soldering while the LED is at high temperature.

Recommended soldering condition.

Reflow Soldering:

Pre-heat 120~150°C, 120sec. MAX., Peak temperature : 240°C Max. Soldering time: 10 sec Max.

Soldering Iron: (Not recommended)

Temperature 300°C Max., Soldering time : 3 sec. Max.(one time only), power dissipation of iron : 20W Max. use SN60 solder of solder with silver content and don't to touch LED lens when soldering.

Wave soldering:

Pre-heat 100°C Max, Pre-heat time 60 sec. Max, Solder wave 260°C Max, Soldering time 5 sec. Max. performed consecutively cooling process is required between 1st and 2nd soldering processes.

4. Lead-Free Soldering

For Reflow Soldering:

- 1、Pre-Heat Temp:150-180°C,120sec.Max.
- 2、Soldering Temp: Temperature Of Soldering Pot Over 230°C,40sec.Max.
- 3、Peak Temperature:260°C、5sec.
- 4、Reflow Repetition:2 Times Max.
- 5、Suggest Solder Paste Formula 93.3 Sn/3.1 Ag/3.1 Bi /0.5 Cu

For Soldering Iron (Not Recommended):

- 1、Iron Tip Temp:350°C Max.
- 2、Soldering Iron:30w Max.
- 3、Soldering Time:3 Sec. Max. One Time.

For Dip Soldering:

- 1、Pre-Heat Temp:150°C Max. 120 Sec. Max.
- 2、Bath Temp:265°C Max.
- 3、Dip Time:5 Sec. Max.

5. Drive Method

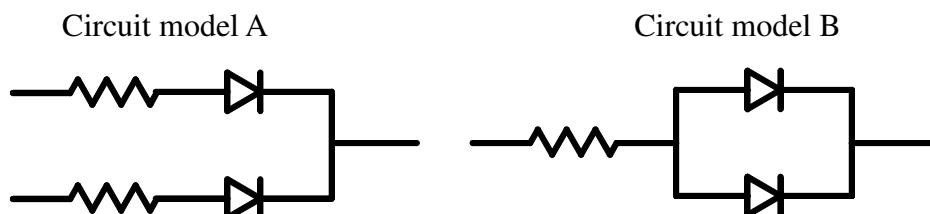

(A)Recommended circuit.

(B)The difference of brightness between LED`s could be found due to the Vf-If characteristics of LED.



SURFACE MOUNT DEVICE LED

Part No.: L-C19F1RGBCT-CC

REV:A / 1

6. Reliability Test

Classification	Test Item	Test Condition	Reference Standard
Endurance Test	Operation Life	Ta= Under Room Temperature As Per Data Sheet Maximum Rating *Test Time= 1000HRS (-24HRS,+72HRS)*@20mA.	MIL-STD-750D: 1026 (1995) MIL-STD-883D: 1005 (1991) JIS C 7021:B-1 (1982)
	High Temperature High Humidity Storage	IR-Reflow In-Board, 2 Times Ta= 65±5°C, RH= 90~95% *Test Time= 1000HRS±2HRS	MIL-STD-202F: 103B(1980) JIS C 7021: B-11 (1982)
	High Temperature Storage	Ta= 105±5°C Test Time= 1000HRS (-24HRS, 72HRS)	MIL-STD-883D: 1008 (1991) JIS C 7021:B-10 (1982)
	Low Temperature Storage	Ta= -55±5°C *Test Time=1000HRS (-24HRS, 72HRS)	JIS C 7021:B-12 (1982)
Environmental Test	Temperature Cycling	105±5°C -55±5°C 10mins 10mins 100 Cycles	MIL-STD-202F: 107D (1980) MIL-STD-750D: 1051(1995) MIL-STD-883D: 1010 (1991) JIS C 7021: A-4 (1982)
	Thermal Shock	IR-Reflow In-Board, 2 Times 105±5°C -55°C±5°C 10mins 10mins 100 Cycles	MIL-STD-202F: 107D(1980) MIL-STD-750D: 1051(1995) MIL-STD-883D: 1011(1991)
	Solder Resistance	Tsol= 260 ± 5°C Dwell Time= 10 ± 1sec	MIL-STD-202F: 210A(1980) MIL-STD-750D: 2031(1995) JIS C 7021: A-1 (1982)
	Solder ability	Tsol= 235 ± 5°C Immersion time 2±0.5 sec Immersion rate 25±2.5 mm/sec Coverage ≥95% of the dipped surface	MIL-STD-202F: 208D(1980) MIL-STD-750D: 2026(1995) MIL-STD-883D: 2003(1991) IEC 68 Part 2-20 JIS C 7021: A-2 (1982)

7. Others:

The appearance and specifications of the product may be modified for improvement without notice.