



PARA LIGHT ELECTRONICS CO., LTD.
11F., No. 8, Jiankang Rd., Zhonghe Dist., New Taipei City 235, Taiwan
Tel: 886-2-2225-3733 Fax: 886-2-2225-4800
E-mail: para@para.com.tw www.paralighttaiwan.com

DATA SHEET

PART NO. : LQS8RGBW538G-GB

REV : A / 2

CUSTOMER'S APPROVAL : _____ DCC : _____



2.4*4.8*7.3mm DIA LED LAMP

LQS8RGBW538G-GB

REV:A / 2

PACKAGE DIMENSIONS

ITEM	MATERIALS
RESIN	Epoxy Resin
LEAD FRAME	Sn Plating iron Alloy

Note:

- 1.All Dimensions are in millimeters.
- 2.Tolerance is $\pm 0.25\text{mm}$ (0.010 ") Unless otherwise specified.
- 3.Protruded resin under flange is 1.5mm(0.059 ") max.
- 4.Lead spacing is measured where the leads emerge from the package.
- 5.Specification are subject to change without notice

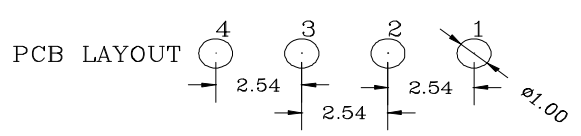
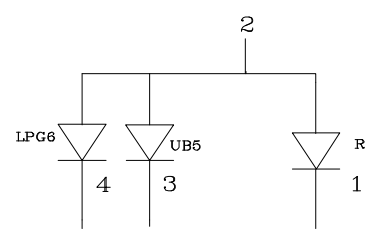
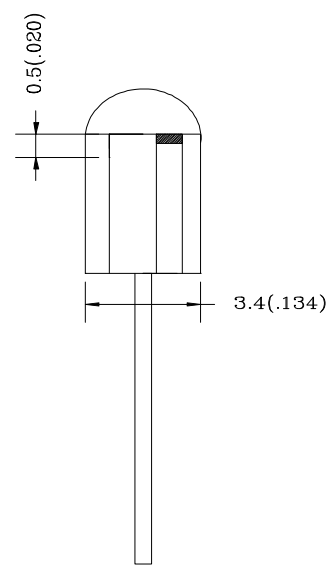
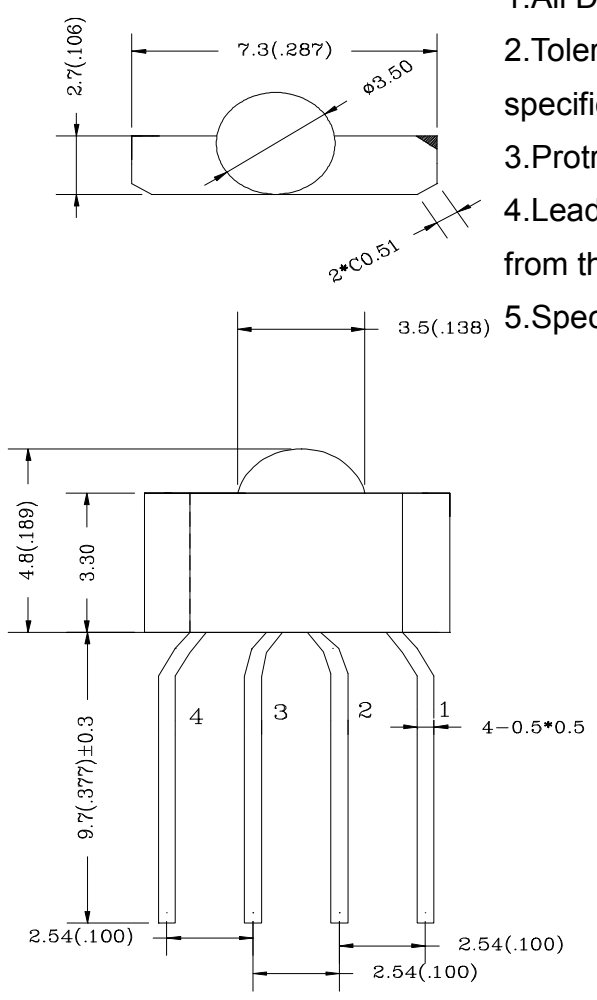



2.4*4.8*7.3mm DIA LED LAMP

LQS8RGBW538G-GB

REV:A / 2

FEATURES

- *High-brightness *High reliability *Low-voltage characteristics
- *Wide view angle *Pb FREE Products *RoHS Compliant

CHIP MATERIALS

- * Dice Material : GaAlInP & GaInN & GaInN
- * Light Color : FULL COLOR(ULTRA RED & ULTRA PURE GREEN & ULTRA BLUE)
- * Lens Color : WHITE DIFFUSED

ABSOLUTE MAXIMUM RATING : (Ta = 25°C)

SYMBOL	DESCRIPTION	ULTRA RED	ULTRA PURE GREEN	ULTRA BLUE	UNIT
PD	Power Dissipation	78	120	120	mW
VR	Reverse Voltage	5			V
IF	Average Forward Current	30			mA
IPF	Peak Forward Current (Duty=0.1,1KHZ)	120			mA
-	Derating Linear From 25°C	0.40			mA/°C
Topr	Operating Temperature Range	-40°C to 85°C			
Tstg	Storage Temperature Range	-40°C to 85°C			

ELECTRO-OPTICAL CHARACTERISTICS : (Ta = 25°C)

SYMBOL	PARAMETER	TEST CONDITION	MIN.	TYP.	MAX.	UNIT	
VF	Forward Voltage	IF=2mA	Ultra Red	1.7		2.0	V
			Ultra Pure Green	2.2		2.5	V
			Ultra Blue	2.5		2.8	V
IR	Reverse Current	VR=5V	Ultra Red			10	μA
			Ultra Pure Green				μA
			Ultra Blue				μA
λD	Dominant Wavelength	IF=2mA	Ultra Red	622		626	nm
			Ultra Pure Green	533		537	nm
			Ultra Blue	463		467	nm
Δλ	Spectral Line Half-Width	IF=2mA	Ultra Red		20		nm
			Ultra Pure Green		18		nm
			Ultra Blue		20		nm
2θ1/2	Half Intensity Angle	IF=2mA	Ultra Red		65		deg
			Ultra Pure Green		65		deg
			Ultra Blue		65		deg
IV	Luminous Intensity	IF=2mA	Ultra Red	30	42	70	mcd
			Ultra Pure Green	200	250	400	mcd
			Ultra Blue	20	30	60	mcd



2.4*4.8*7.3mm DIA LED LAMP

LQS8RGBW538G-GB

REV:A / 2

R

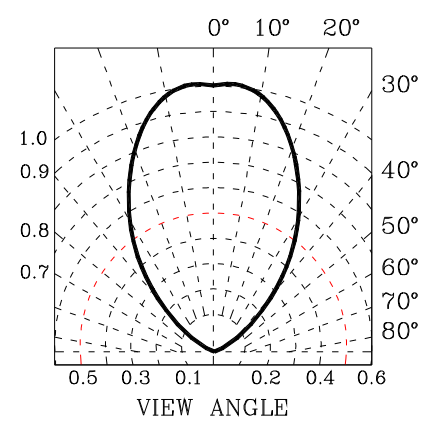
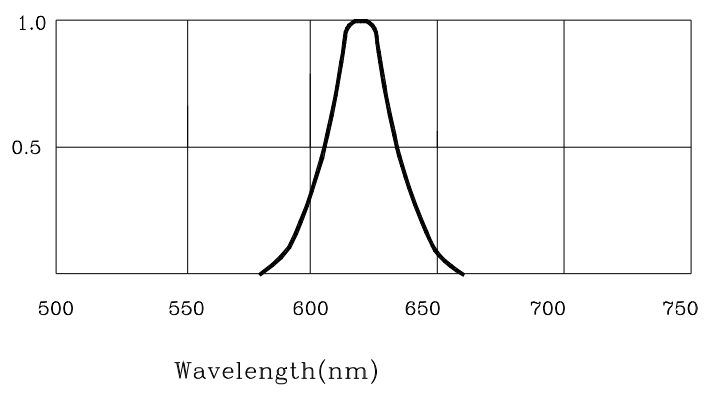
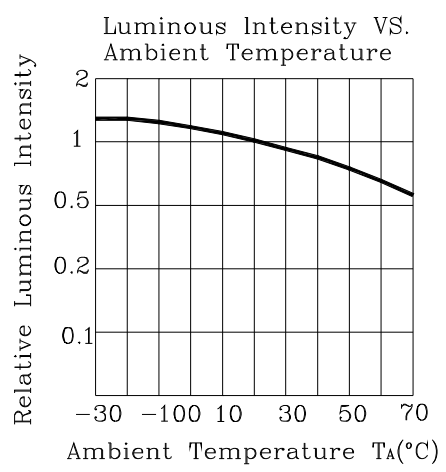
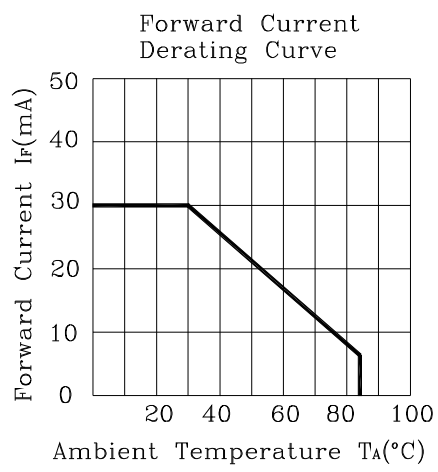
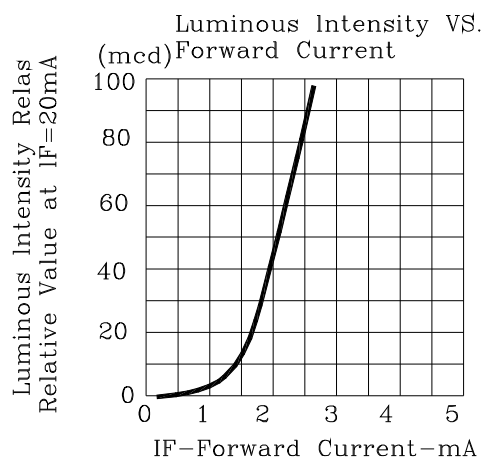
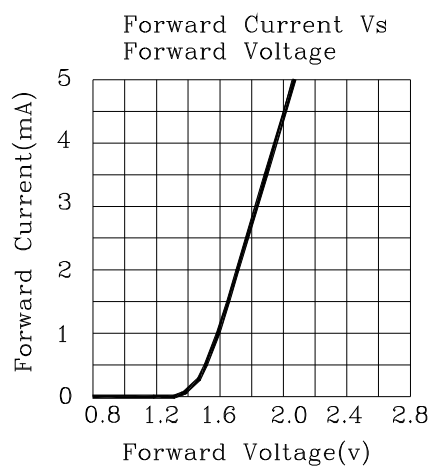



2.4*4.8*7.3mm DIA LED LAMP

LQS8RGBW538G-GB

REV:A / 2

LPG6

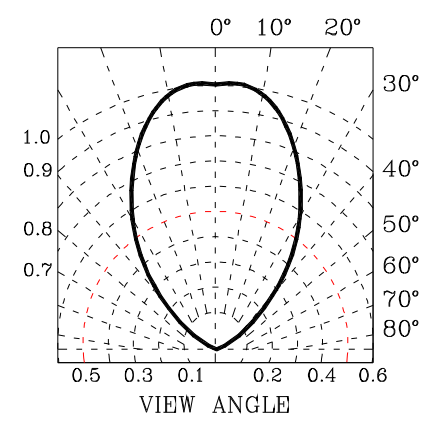
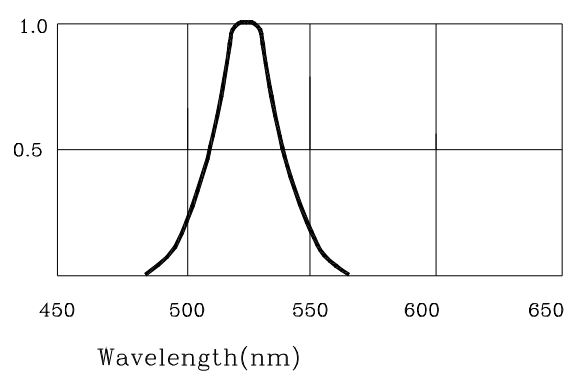
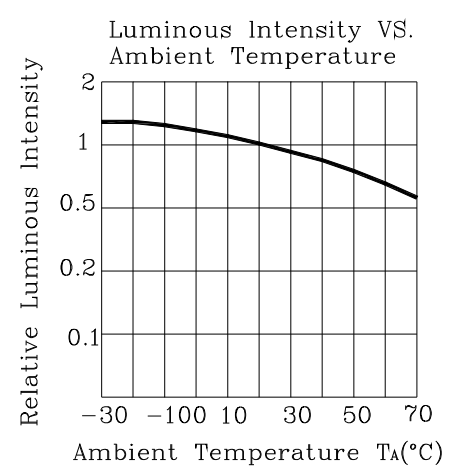
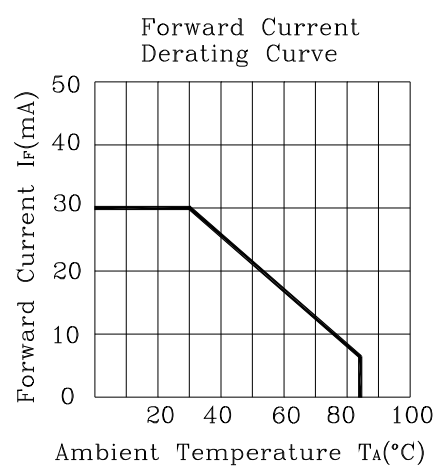
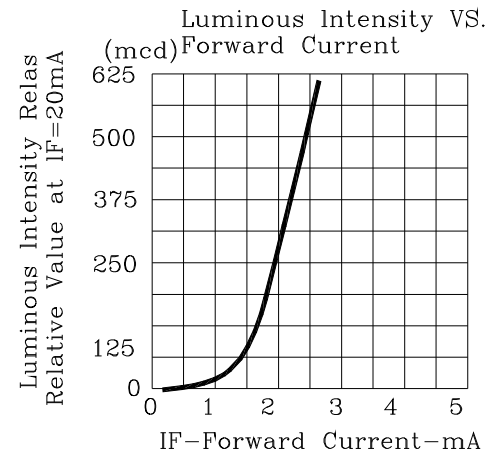
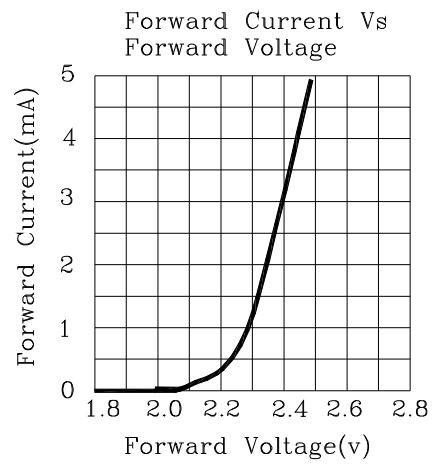



2.4*4.8*7.3mm DIA LED LAMP

LQS8RGBW538G-GB

REV: A / 2

UB5

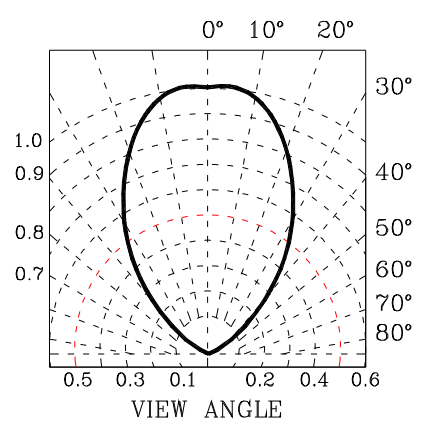
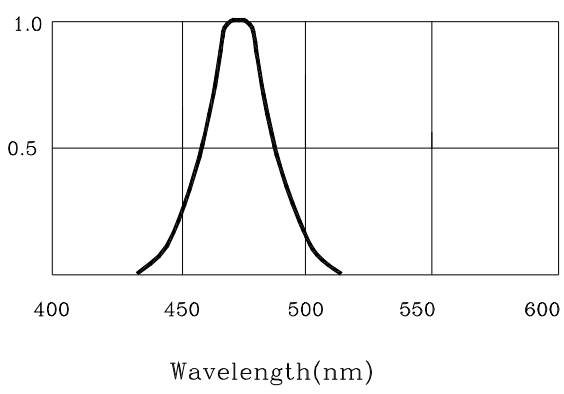
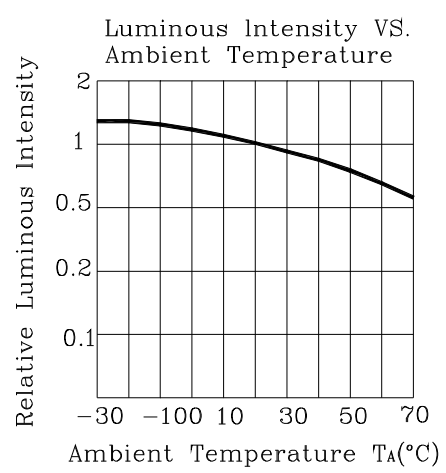
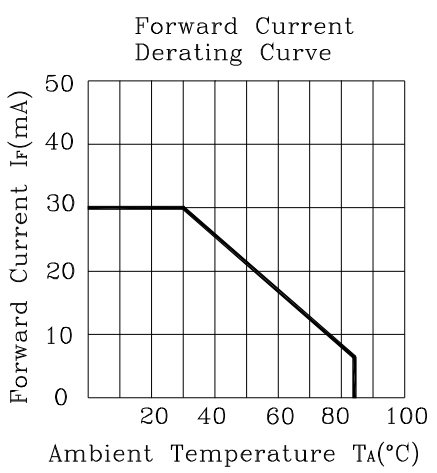
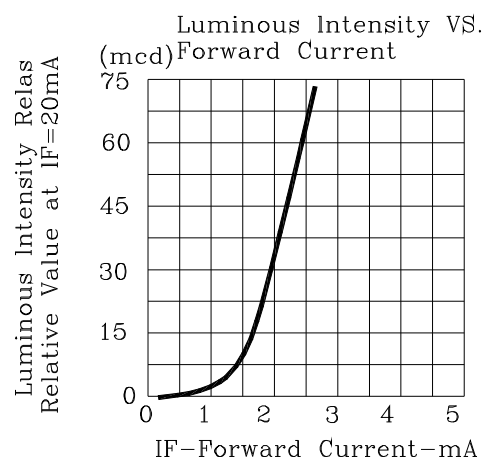
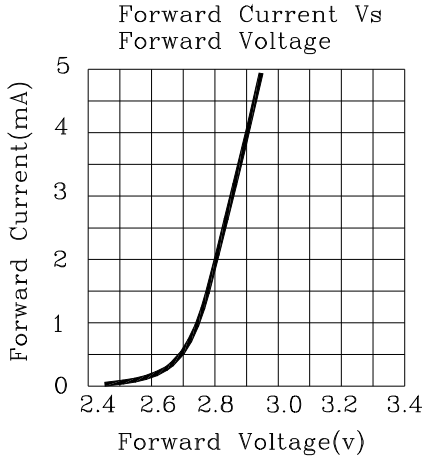



2.4*4.8*7.3mm DIA LED LAMP

LQS8RGBW538G-GB

REV: A / 2

Label Explanation

 光鼎电子股份有限公司 PARA LIGHT ELECTRONICS CO.,LTD.	
PARA NO. :	
LOT NO. :	INSPECTED
BIN :	
Q' TY :	PCS
N. W :	g

PARA NO. : Refer to p14

LOT NO. : E L L 4 7 0009

A B C D E F

A---E: For series number

B---L: Local F: Foreign

C---L: LAMP

D---Year

E---Month

F---SPEC.

N'W : Net Weight



2.4*4.8*7.3mm DIA LED LAMP

LQS8RGBW538G-GB

REV:A / 2

●SOLDERING

METHOD	SOLDERING CONDITIONS	REMARK
DIP SOLDERING	Bath temperature: 270°C max Immersion time: with 5 sec, 1 time	<ul style="list-style-type: none"> Solder no closer than 3mm from the base of the package Using soldering flux, "RESIN FLUX" is recommended. Attached data of temperature cure for your reference
SOLDERING IRON	Soldering iron: 30W or smaller Temperature at tip of iron: 400°C or lower Soldering time: within 3 sec.	<ul style="list-style-type: none"> During soldering, take care not to press the tip of iron against the lead. (To prevent heat from being transferred directly to the lead, hold the lead with a pair of tweezers while soldering

1) When soldering the lead of LED in a condition that the package is fixed with a panel (See Fig.1), be careful not to stress the leads with iron tip.

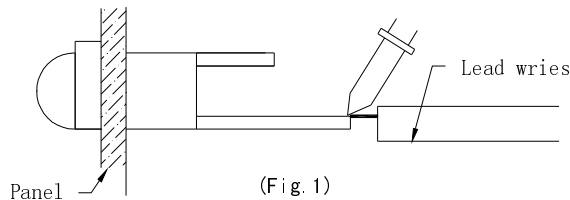

2) When soldering wire to the lead, work with a Fig (See Fig.2) to avoid stressing the package.

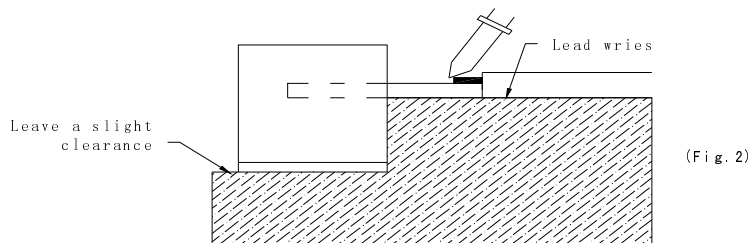

Regarding solution in the tinning oven for product-tinning, compound sub-solution made of tin & copper and silver is proposed with the temperature of Celsius 260. The proportion of the alloyed solution is tin 95.5: copper 3.5: silver 0.5 by percentage. The time of tinning is constantly 3 seconds.

- 3) Similarly, when a jig is used to solder the LED to PC board, take care as much as possible to avoid steering the leads (See Fig.3).

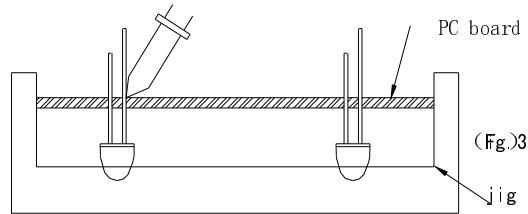

- 4) Repositioning after soldering should be avoided as much as possible. If inevitable, be sure to preserve the soldering conditions with irons stated above: select a best-suited method that assures the least stress to the LED.
- 5) Lead cutting after soldering should be performed only after the LED temperature has returned to normal temperature.

● STORAGE

- 1) The LEDs should be stored at 30°C or less and 70% RH or less after being shipped from PARA and the storage life limits are 3 months .
- 2) PARA LED lead frames are comprised of a stannum plated iron alloy. The silver surface may be affected by environments which contain corrosive gases and so on. Please avoid conditions which may cause the LEDs to corrode, tarnish or discolor. This corrosion or discoloration may cause difficulty during soldering operations. It is recommended that the LEDs be used as soon as possible.

Please avoid rapid transitions in ambient temperature, especially, in high humidity environments where condensation can occur.

● STATIC ELECTRICITY

- 1) Static electricity or surge voltage damages the LEDs.
It is recommended that a wrist band or an anti-electrostatic glove be used when handling the LEDs.
- 2) All devices, equipment and machinery must be properly grounded. It is recommended that measures be taken against surge voltage to the equipment that mounts the LEDs.
- 3) When inspecting the final products in which LEDs were assembled, it is recommended to check whether the assembled LEDs are damaged by static electricity or not. It is easy to find static-damaged LEDs by a light-on test or a VF test at a lower current (below 1mA is recommended).
- 4) Damaged LEDs will show some unusual characteristics such as the leak current remarkably increases, the forward voltage becomes lower, or the LEDs do not light at the low current .

Criteria : (VF>2.0V at IF=0.5mA)

•LED MOUNTING METHOD

4) When mounting the LED by using a case, as shown Fig.4, ensure that the mounting holds on the PC board match the pitch of the leads correctly-tolerance of dimensions of the respective components including the LED should be taken into account especially when designing the case, PC board, etc. to prevent pitch misalignment between the leads and board holes, the diameter of the board holes should be slightly larger than the size of the lead. Alternatively, the shape of the holes should be made oval. (See Fig.4)

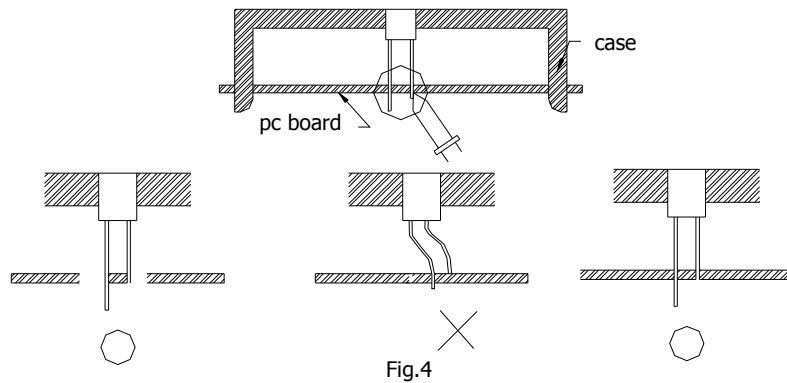

5) Use LEDs with stand-off (Fig.5) or the tube or spacer made of resin (Fig.6) to position the LEDs.

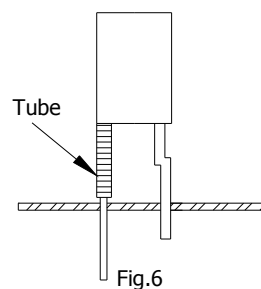
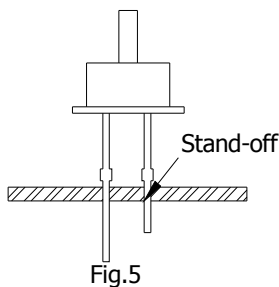

•FORMED LEAD

- 1) The lead should be bent at a point located at least 2mm away from the package. Bending should be performed with base fixed means of a jig or pliers (Fig.7)

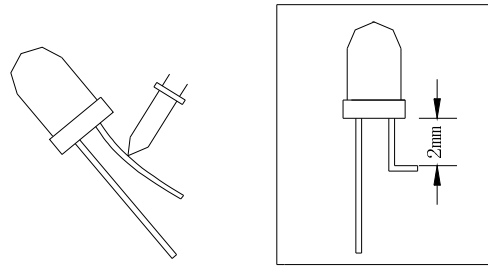

Fig. 7

- 2) Forming lead should be carried out prior to soldering and never during or after soldering.
- 3) Form the lead to ensure alignment between the leads and the hole on board, so that stress against the LED is prevented. (Fig.8)

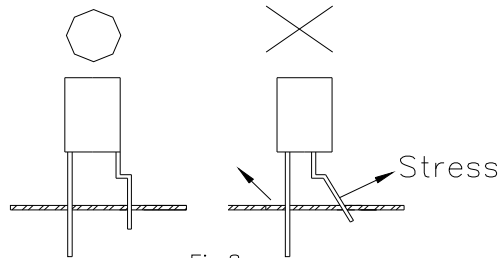

Fig.8

•LEAD STRENGTH

- 1) Bend strength
Do not bend the lead more than twice. (Fig.9)

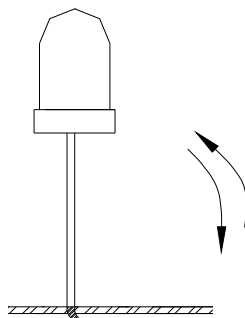

Fig.9



2.4*4.8*7.3mm DIA LED LAMP

LQS8RGBW538G-GB

REV:A / 2

2) Tensile strength (@Room Temperature)

If the force is 1kg or less, there will be no problem. (Fig.10)



● HEAT GENERATION

- 1) Thermal design of the end product is of paramount importance. Please consider the heat generation of the LED when making the system design. The coefficient of temperature increase per input electric power is affected by the thermal resistance of the circuit board and density of LED placement on the board, as well as other components. It is necessary to avoid intense heat generation and operate within the maximum ratings given in this specification.

The operating current should be decided after considering the ambient maximum temperature of LEDs.

●CHEMICAL RESISTANCE

- 1) Avoid exposure to chemicals as it may attack the LED surface and cause discoloration.
- 2) When washing is required, refer to the following table for the proper chemical to be used. (Immersion time: within 3 minutes at room temperature.)

SOLVENT	ADAPTABILITY
Freon TE	⊙
Chloroethene	×
Isopropyl Alcohol	⊙
Thinner	×
Acetone	×
Trichloroethylene	×

NOTE: Influences of ultrasonic cleaning of the LED resin body differ depending on such factors as the oscillator output, size of the PC board and the way in which the LED is mounted. Therefore, ultrasonic cleaning should only be performed after confirming there is no problem by conducting a test under practical.

⊙--Usable ×--Do not use.



2.4*4.8*7.3mm DIA LED LAMP

LQS8RGBW538G-GB

REV:A / 2

•OTHERS

- 1) Care must be taken to ensure that the reverse voltage will not exceed the absolute maximum rating when using the LEDs with matrix drive.
- 2) Flashing lights have been known to cause discomfort in people; you can prevent this by taking precautions during use. Also, people should be cautious when using equipment that has had LEDs incorporated into it.
- 3) The LEDs described in this brochure are intended to be used for ordinary electronic equipment (such as office equipment, communications equipment, measurement instruments and household appliances). Consult PARA's sales staff in advance for information on the applications in which exceptional quality and reliability are required , particularly when the failure or malfunction of the LEDs may directly jeopardize life or health (such as for airplanes, aerospace, submersible repeaters, nuclear reactor control systems, automobiles, traffic control equipment, life support systems and safety devices).
- 4) User shall not reverse engineer by disassembling or analysis of the LEDs without having prior written consent from PARA. When defective LEDs are found, the User shall inform PARA directly before disassembling or analysis.
- 5) The formal specifications must be exchanged and signed by both parties before large volume purchase begins.
- 6) The appearance and specifications of the product may be modified for improvement without notice.



2.4*4.8*7.3mm DIA LED LAMP

LQS8RGBW538G-GB

REV:A / 2

BIN CODE LIST

Luminous Intensity(IV), Unit:mcd@2mA		
Bin Code	Min	Max
WA	300	500
WB	500	700
WC	700	900

	A						B				
X	0.25	0.302	0.302	0.25	0.25	X	0.302	0.341	0.341	0.302	0.302
Y	0.16	0.18	0.108	0.1	0.16	Y	0.18	0.195	0.114	0.108	0.18
	C						D				
X	0.341	0.38	0.38	0.341	0.341	X	0.38	0.411	0.411	0.38	0.38
Y	0.195	0.21	0.12	0.114	0.195	Y	0.21	0.225	0.132	0.12	0.21
	E						F				
X	0.411	0.446	0.446	0.411	0.411	X	0.446	0.49	0.49	0.446	0.446
Y	0.225	0.24	0.144	0.132	0.225	Y	0.24	0.26	0.16	0.144	0.24



2.4*4.8*7.3mm DIA LED LAMP

LQS8RGBW538G-GB

REV:A / 2

LED Lamps:

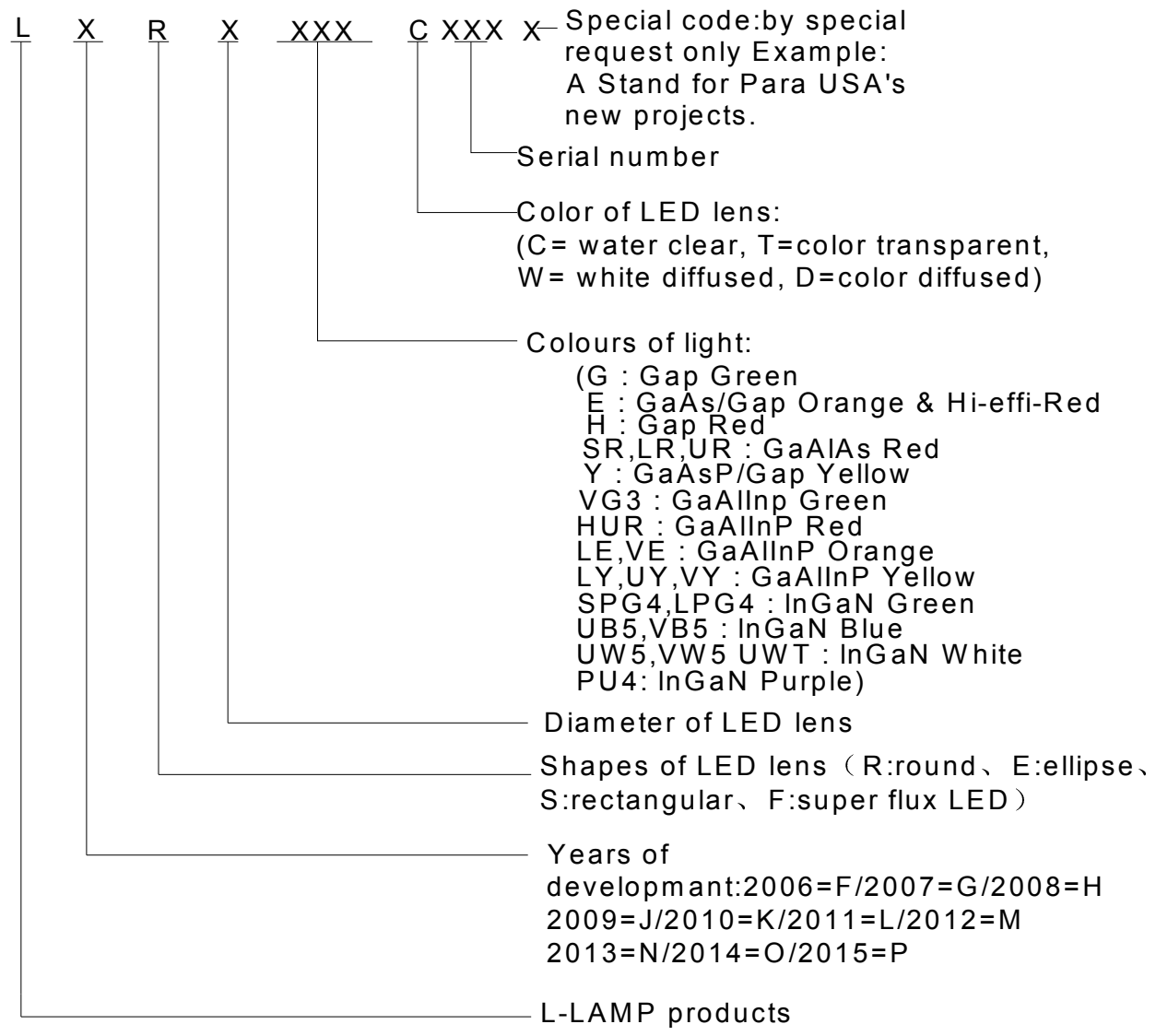



2.4*4.8*7.3mm DIA LED LAMP

LQS8RGBW538G-GB

REV:A / 2

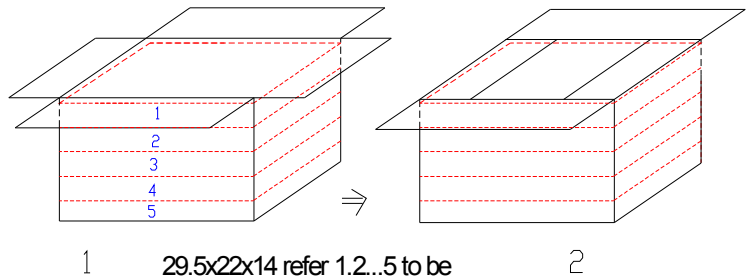
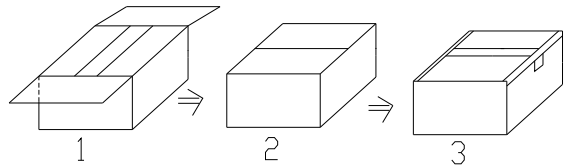
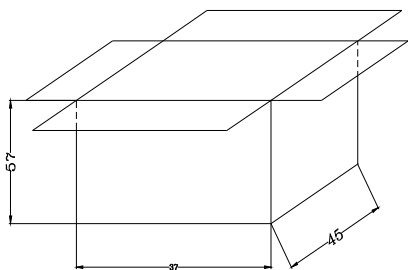
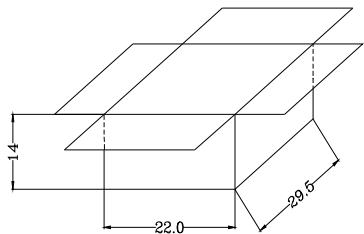

29.5x22x14 refer 1.2...5 to be continued 45x30.5x57.

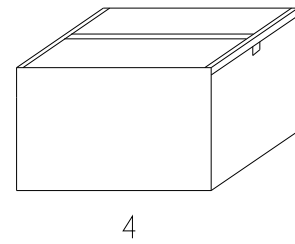
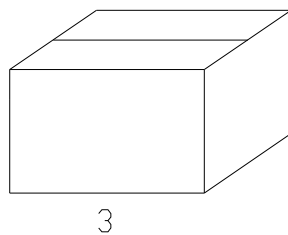

LQS8RGBW538G-GB Bpackage rule Note:

- 1、 29.5x22x14 presents little package box ,20little bags in every 29.5x22x14,0.5KPCS in every bag.
- 2、 45x30.5x57 presents big package box, five little 29.5x22x14 boxes in every 45x30.5x57,total 50.0KPCS in every 45x30.5x57.
- 3、 Specific package course refers to the attached graph.