

TO-92 Plastic-Encapsulate Transistors

S9018 TRANSISTOR (NPN)

FEATURES

- High Current Gain Bandwidth Product

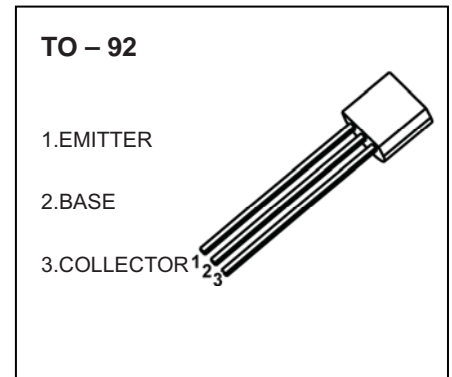

MARKING

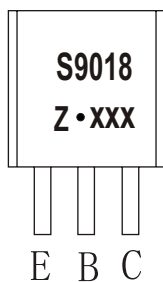

S9018=Device code
 Solid dot=Green molding compound device,
 if none,the normal device
 Z=Rank of h_{FE} ,
 XXX=Code

Equivalent Circuit

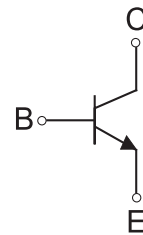

ORDERING INFORMATION

Part Number	Package	Packing Method	Pack Quantity
S9018	TO-92	Bulk	1000pcs/Bag
S9018-TA	TO-92	Tape	2000pcs/Box

MAXIMUM RATINGS ($T_a=25^{\circ}\text{C}$ unless otherwise noted)

Symbol	Parameter	Value	Unit
V_{CBO}	Collector-Base Voltage	25	V
V_{CEO}	Collector-Emitter Voltage	18	V
V_{EBO}	Emitter-Base Voltage	4	V
I_c	Collector Current -Continuous	0.05	A
P_D	Collector Power Dissipation	400	mW
$R_{\theta JA}$	Thermal Resistance from Junction to Ambient	312.5	$^{\circ}\text{C} / \text{W}$
T_J, T_{stg}	Operation Junction and Storage Temperature Range	-55~+150	$^{\circ}\text{C}$

ELECTRICAL CHARACTERISTICS

$T_a=25^\circ\text{C}$ unless otherwise specified

Parameter	Symbol	Test conditions	Min	Typ	Max	Unit
Collector-base breakdown voltage	$V_{(BR)CBO}$	$I_C=100\mu\text{A}, I_E=0$	25			V
Collector-emitter breakdown voltage	$V_{(BR)CEO}$	$I_C=0.1\text{mA}, I_B=0$	18			V
Emitter-base breakdown voltage	$V_{(BR)EBO}$	$I_E=100\mu\text{A}, I_C=0$	4			V
Collector cut-off current	I_{CBO}	$V_{CB}=20\text{V}, I_E=0$			0.1	nA
Collector cut-off current	I_{CEO}	$V_{CE}=15\text{V}, I_B=0$			0.1	μA
Emitter cut-off current	I_{EBO}	$V_{EB}=3\text{V}, I_C=0$			0.1	μA
DC current gain	h_{FE}	$V_{CE}=5\text{V}, I_C=1\text{mA}$	28		270	
Collector-emitter saturation voltage	$V_{CE(sat)}$	$I_C=10\text{mA}, I_B=1\text{mA}$			0.5	V
Base-emitter saturation voltage	$V_{BE(sat)}$	$I_C=10\text{mA}, I_B=1\text{mA}$			1.42	V
Transition frequency	f_T	$V_{CE}=5\text{V}, I_C=50\text{mA}, f=400\text{MHz}$		800		MHz

CLASSIFICATION OF h_{FE}

RANK	D	E	F	G	H	I	J
RANGE	28-45	39-60	54-80	72-108	97-146	132-198	180-270

Typical Characteristics

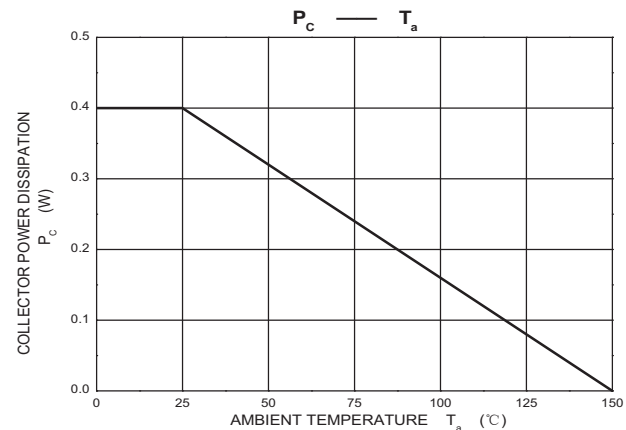
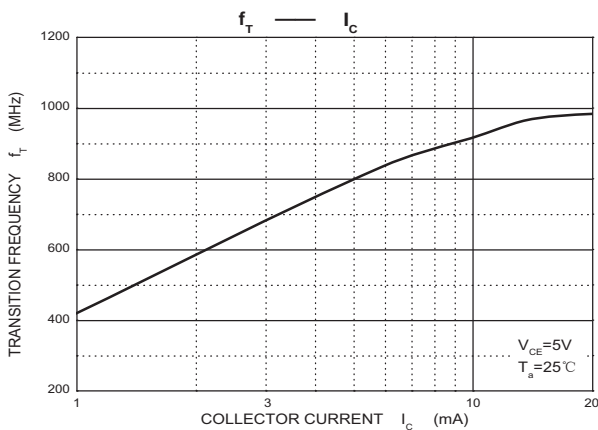
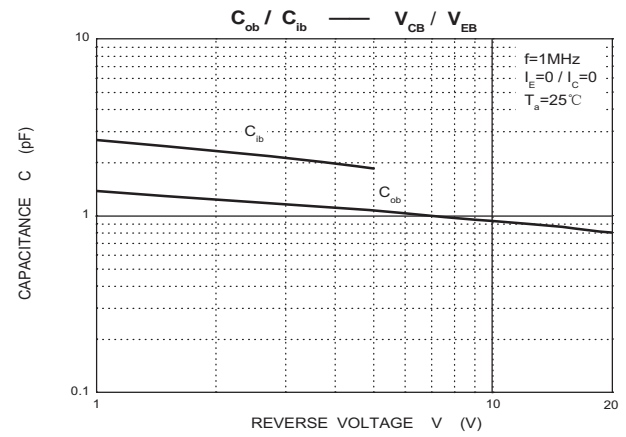
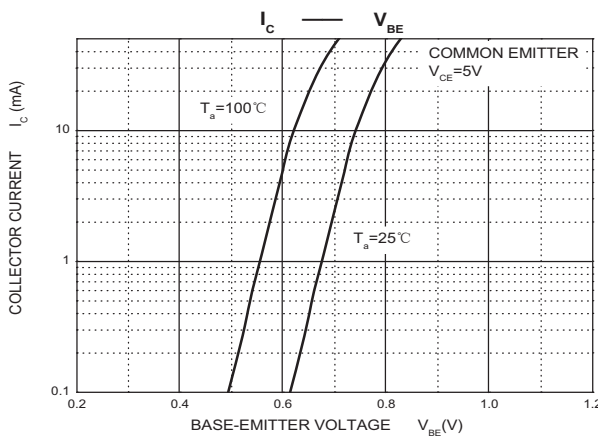
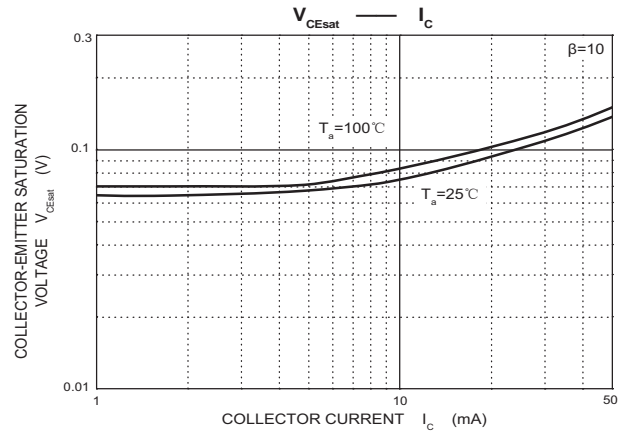
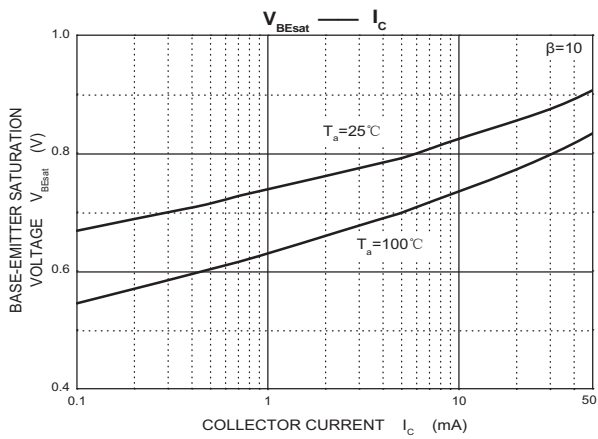
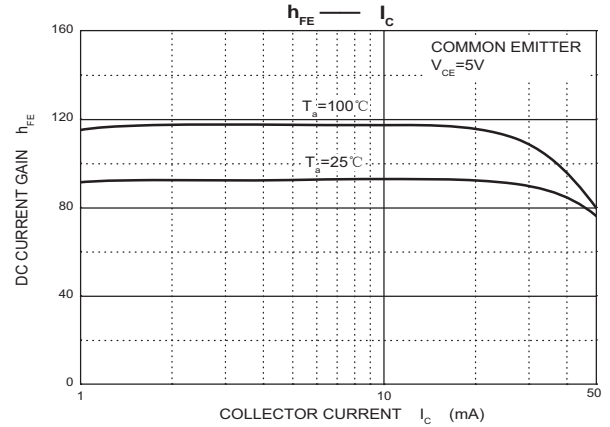
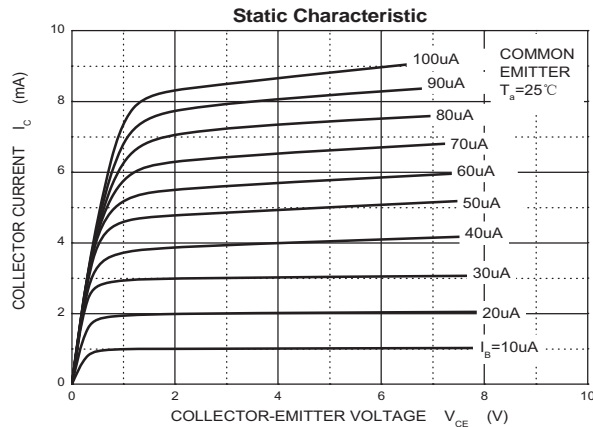

TO-92 Package Outline Dimensions

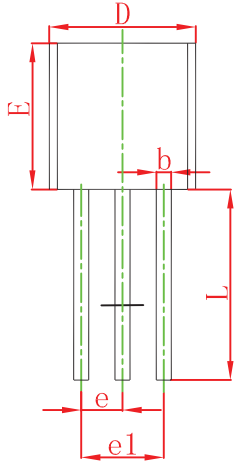
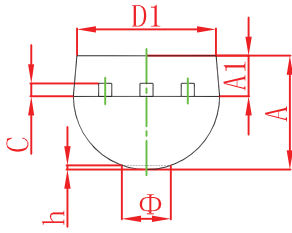

Symbol	Dimensions In Millimeters		Dimensions In Inches	
	Min	Max	Min	Max
A	3.300	3.700	0.130	0.146
A1	1.100	1.400	0.043	0.055
b	0.380	0.550	0.015	0.022
c	0.360	0.510	0.014	0.020
D	4.300	4.700	0.169	0.185
D1	3.430		0.135	
E	4.300	4.700	0.169	0.185
e	1.270 TYP		0.050 TYP	
e1	2.440	2.640	0.096	0.104
L	14.100	14.500	0.555	0.571
Φ		1.600		0.063
h	0.000	0.380	0.000	0.015

TO-92 Suggested Pad Layout

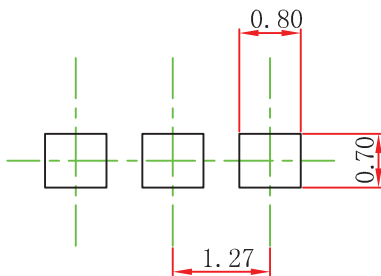

Note:

1. Controlling dimension: in millimeters.
2. General tolerance: ± 0.05 mm.
3. The pad layout is for reference purposes only.

NOTICE

JSCJ reserves the right to make modifications, enhancements, improvements, corrections or other changes without further notice to any product herein. JSCJ does not assume any liability arising out of the application or use of any product described herein.

TO-92 Tape and Reel

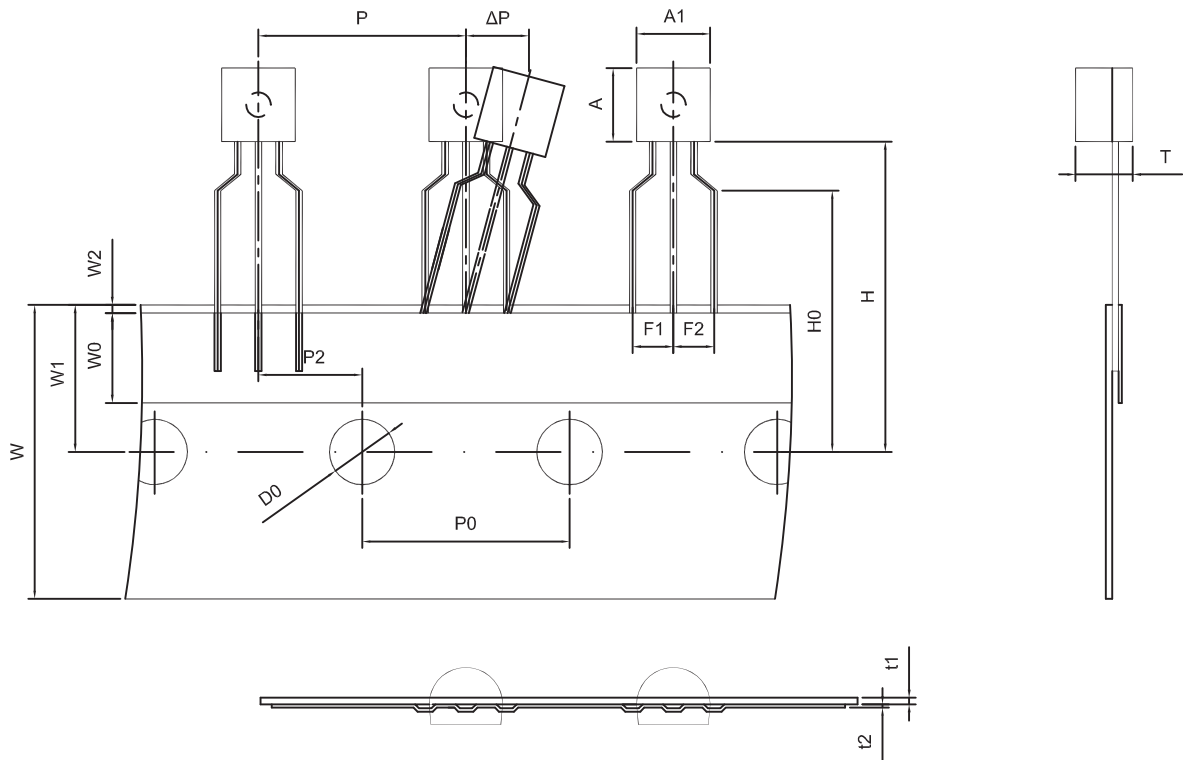

Dimensions are in millimeter

A1	A	T	P	P0	P2	F1	F2	W
4.5	4.5	3.5	12.7	12.7	6.35	2.5	2.5	18.0
W0	W1	W2	H	H0	D0	t1	t2	ΔP
6.0	9.0	1.0 MAX.	19.0	16.0	4.0	0.4	0.2	0

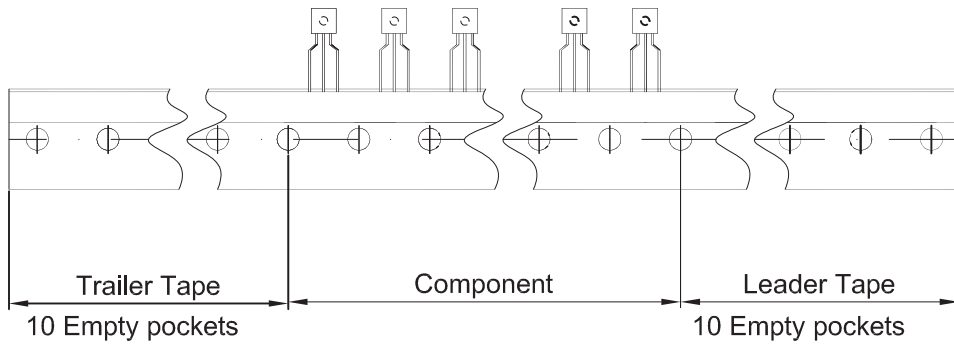

Package	Box	Box Size(mm)	Carton	Carton Size(mm)
TO-92	2000 pcs	333×162×43	20,000 pcs	350×340×250