



TO-92 Plastic-Encapsulate Transistors

KTC3203 TRANSISTOR (NPN)

FEATURES

- Complementary to KTA1271

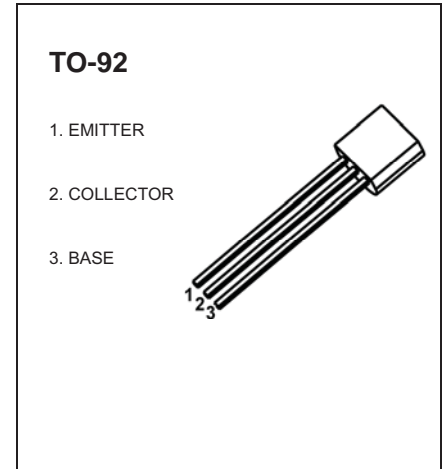

MARKING

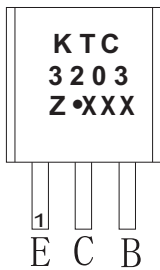

KTC3203=Device code
 Solid dot=Green molding compound device,
 if none,the normal device
 Z=Rank of hFE
 XXX=Code

Equivalent Circuit

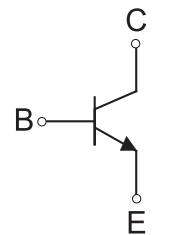

ORDERING INFORMATION

Part Number	Package	Packing Method	Pack Quantity
KTC3203	T, -92	Bulk	1000pcs/Bag
KTC3203-TA	T, -92	Tape	2000pcs/Box

MAXIMUM RATINGS (Ta=25°C unless otherwise noted)

Symbol	Parameter	Value	Unit
V _{CBO}	Collector-Base Voltage	35	V
V _{CEO}	Collector-Emitter Voltage	30	V
V _{EBO}	Emitter-Base Voltage	5	V
I _C	Collector Current -Continuous	0.8	A
P _D	Collector Power Dissipation	625	mW
R _{θJA}	Thermal Resistance from Junction to Ambient	200	°C /W
T _J ,T _{stg}	Operation Junction and Storage Temperature Range	-55~+150	°C

ELECTRICAL CHARACTERISTICS

$T_a=25^\circ\text{C}$ unless otherwise specified

Parameter	Symbol	Test conditions	Min	Typ	Max	Unit
Collector-base breakdown voltage	$V_{(BR)CBO}$	$I_C = 0.1\text{mA}, I_B=0$	35			V
Collector-emitter breakdown voltage	$V_{(BR)CEO}$	$I_C = 10\text{mA}, I_B=0$	30			V
Emitter-base breakdown voltage	$V_{(BR)EBO}$	$I_E = 0.1\text{mA}, I_C=0$	5			V
Collector cut-off current	I_{CBO}	$V_{CB}= 35\text{V}, I_E=0$			0.1	μA
Collector cut-off current	I_{CEO}	$V_{CE}= 25\text{V}, I_B=0$			0.2	μA
Emitter cut-off current	I_{EBO}	$V_{EB}= 5\text{V}, I_C=0$			0.1	μA
DC current gain	$h_{FE(1)}$	$V_{CE}=1\text{V}, I_C= 100\text{mA}$	100		320	
	$h_{FE(2)}$	$V_{CE}=1\text{V}, I_C= 700\text{mA}$	35			
Collector-emitter saturation voltage	$V_{CE(sat)}$	$I_C= 500\text{mA}, I_B= 20\text{mA}$			0.5	V
Base-emitter voltage	V_{BE}	$V_{CE}= 1\text{V}, I_C= 10\text{mA}$			0.8	V
Transition frequency	f_T	$V_{CE}= 5\text{V}, I_C= 10\text{mA}$		120		MHz
Collector Output Capacitance	C_{ob}	$V_{CB}=10\text{V}, I_E= 0, f=1\text{MHz}$		13		pF

CLASSIFICATION OF $h_{FE(1)}$

Rank	O	Y
Range	100-200	160-320

Typical Characteristics

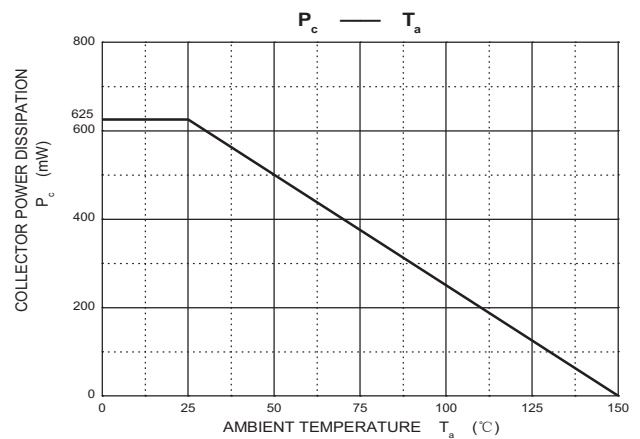
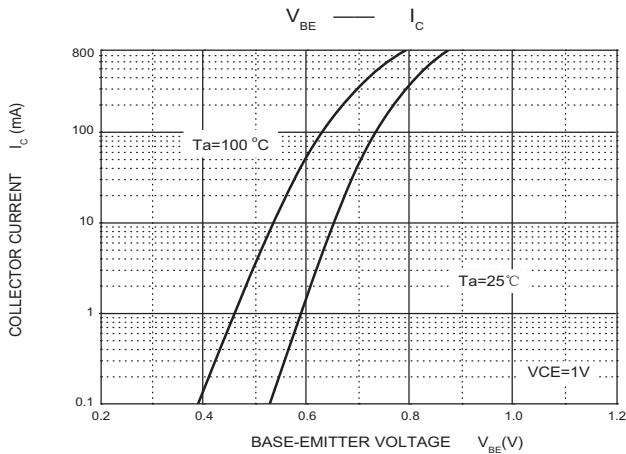
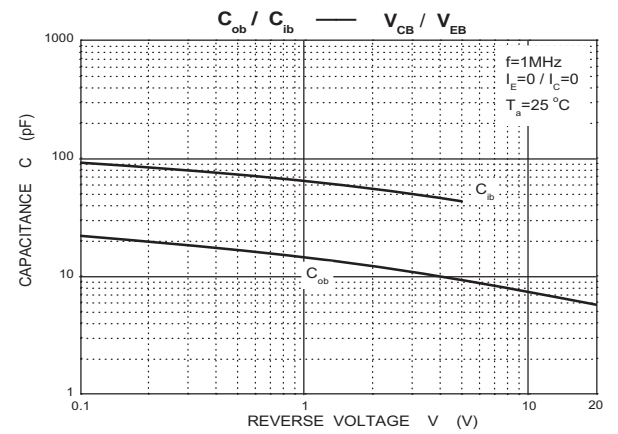
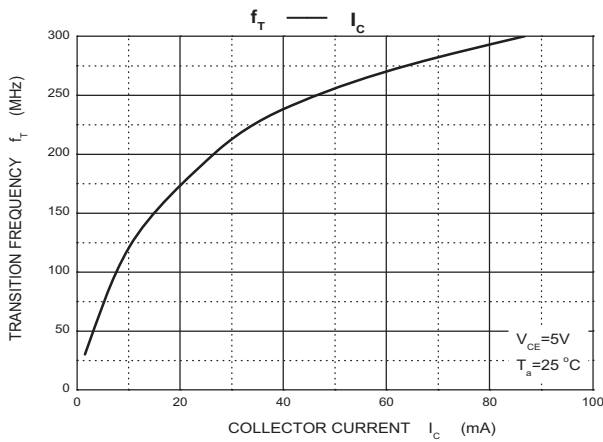
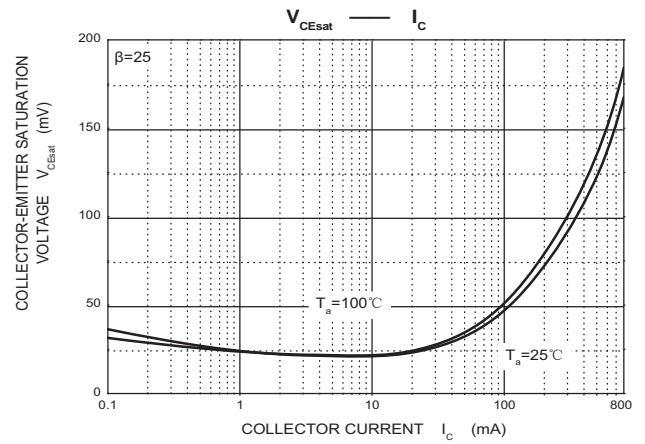
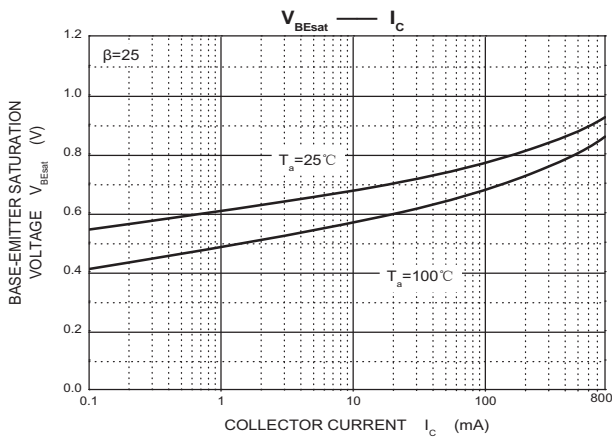
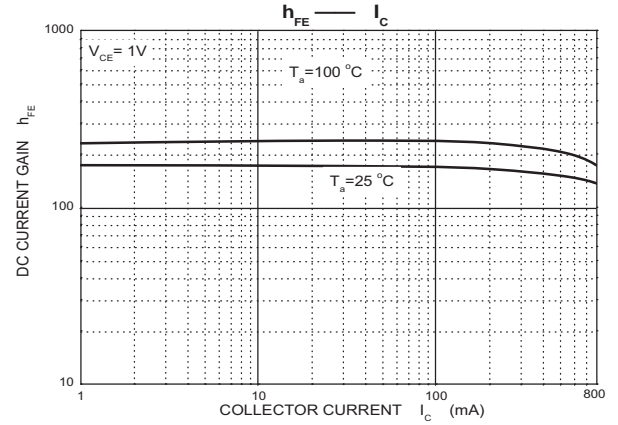
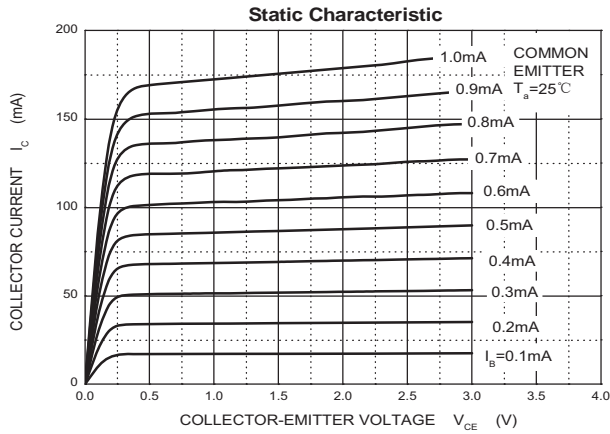

TO-92 Package Outline Dimensions

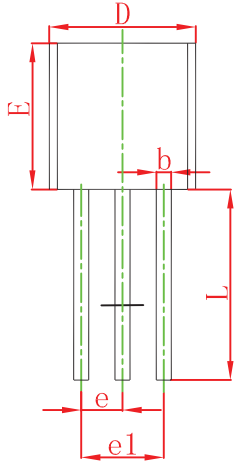
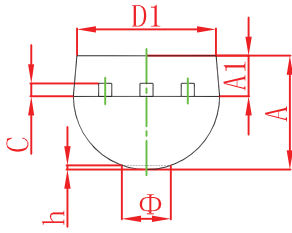

Symbol	Dimensions In Millimeters		Dimensions In Inches	
	Min	Max	Min	Max
A	3.300	3.700	0.130	0.146
A1	1.100	1.400	0.043	0.055
b	0.380	0.550	0.015	0.022
c	0.360	0.510	0.014	0.020
D	4.300	4.700	0.169	0.185
D1	3.430		0.135	
E	4.300	4.700	0.169	0.185
e	1.270 TYP		0.050 TYP	
e1	2.440	2.640	0.096	0.104
L	14.100	14.500	0.555	0.571
Φ		1.600		0.063
h	0.000	0.380	0.000	0.015

TO-92 Suggested Pad Layout

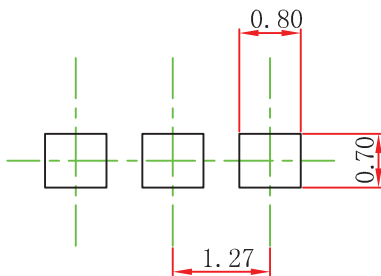

Note:

1. Controlling dimension: in millimeters.
2. General tolerance: $\pm 0.05\text{mm}$.
3. The pad layout is for reference purposes only.

NOTICE

JSCJ reserves the right to make modifications, enhancements, improvements, corrections or other changes without further notice to any product herein. JSCJ does not assume any liability arising out of the application or use of any product described herein.

TO-92 PACKAGE TAPING DIMENSION

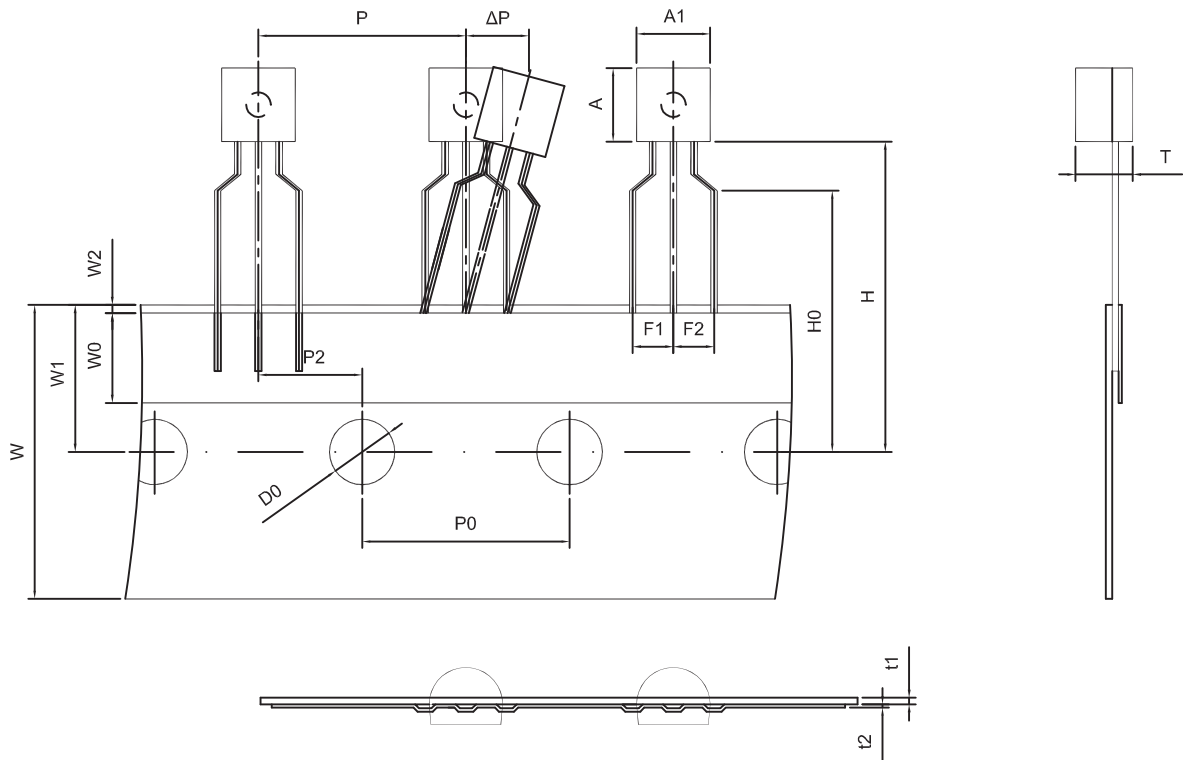

Dimensions are in millimeter								
A1	A	T	P	P0	P2	F1	F2	W
4.5	4.5	3.5	12.7	12.7	6.35	2.5	2.5	18.0
W0	W1	W2	H	H0	D0	t1	t2	ΔP
6.0	9.0	1.0 MAX.	19.0	16.0	4.0	0.4	0.2	0

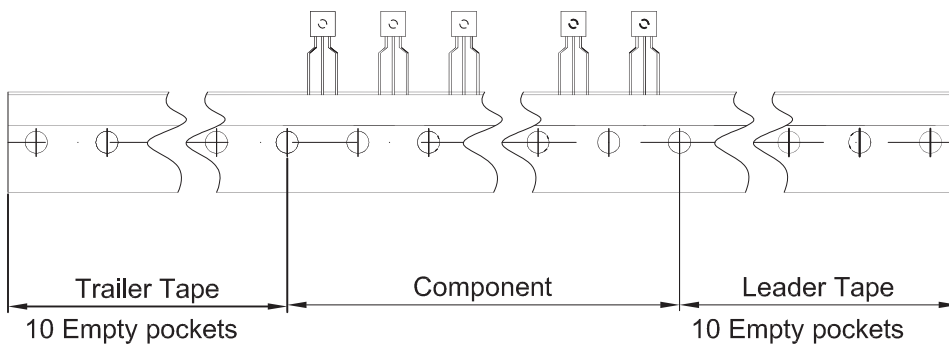

Package	Box	Box Size(mm)	Carton	Carton Size(mm)
TO-92	2000 pcs	333×162×43	20,000 pcs	350×340×250