

## IGBT in TO-247

### Features

- 650V 40A,  $V_{CE(sat)}(typ.) = 2.5V @ 40A$
- Field Stop IGBT Technology
- 10 $\mu$ s Short Circuit Capability
- Square RBSOA
- Positive  $V_{CE(on)}$  Temperature Coefficient

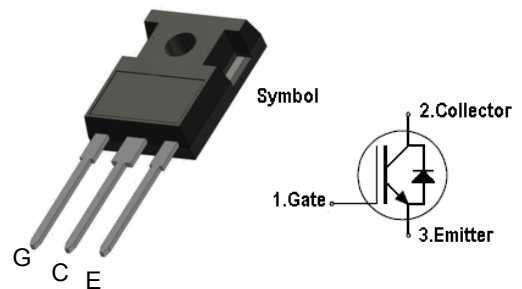

### Mechanical Data

- **Case:** TO-247 (plastic package).  
Lead free; RoHS compliant
- **Molding Compound Flammability Rating:**  
UL 94 V-0
- **Terminals:** High temperature soldering guaranteed:  
260 °C/10 sec. at terminals

### Benefits

- High Efficiency for Motor Control
- Rugged Performance
- Excellent Current Sharing in Parallel Operation

### Applications

CREATEK's IGBTs offer lower losses and higher energy for application such as motor drive ,UPS, inverter and other soft switching applications.

### Absolute Maximum Ratings

Symbol	Parameter	Value	Units
$V_{CES}$	Collector-Emitter Voltage	650	V
$V_{GES}$	Gate-Emitter Voltage	$\pm 30$	V
$I_C$	Continuous Collector Current ( $T_C=25^\circ C$ )	80	A
	Continuous Collector Current ( $T_C=100^\circ C$ )	40	A
$I_{CM}$	Pulsed Collector Current (Note 1)	160	A
$I_F$	Diode Continuous Forward Current ( $T_C=100^\circ C$ )	40	A
$I_{FM}$	Diode Maximum Forward Current (Note 1)	160	A
$t_{sc}$	Short Circuit Withstand Time	10	us
$I_{SC}$	Short Circuit Current	220	A
$P_D$	Maximum Power Dissipation ( $T_C=25^\circ C$ )	312	W
$P_D$	Maximum Power Dissipation ( $T_C=100^\circ C$ )	125	W
$T_J$	Operating Junction Temperature Range	-55 to +150	
$T_{STG}$	Storage Temperature Range	-55 to +150	

### Thermal Characteristics

Symbol	Parameter	Max.	Units
$R_{th j-c}$	Thermal Resistance, Junction to case for IGBT	0.40	$^\circ C/W$
$R_{th j-c}$	Thermal Resistance, Junction to case for Diode	0.81	$^\circ C/W$
$R_{th j-a}$	Thermal Resistance, Junction to Ambient	80	$^\circ C/W$

## Electrical Characteristics (TC=25°C unless otherwise noted)

Symbol	Parameter	Test Conditions	Min.	Typ.	Max.	Units
$BV_{CES}$	Collector-Emitter Breakdown Voltage	$V_{GE} = 0V, I_C = 250\mu A$	650		-	V
$I_{CES}$	Collector-Emitter Leakage Current	$V_{CE} = 650V, V_{GE} = 0V$	-	-	250	$\mu A$
$I_{GES}$	Gate Leakage Current, Forward	$V_{GE} = 30V, V_{CE} = 0V$	-	-	100	nA
	Gate Leakage Current, Reverse	$V_{GE} = -30V, V_{CE} = 0V$	-	-	-100	nA
$V_{GE(th)}$	Gate Threshold Voltage	$V_{GE} = V_{CE}, I_C = 250\mu A$	4.0		5.5	V
$V_{CE(sat)}$	Collector-Emitter Saturation Voltage	$V_{GE} = 15V, I_C = 40A$	-	2.3		V
$Q_g$	Total Gate Charge	$V_{CC} = 480V$ $V_{GE} = 15V$ $I_C = 40A$	-	142		nC
$Q_{ge}$	Gate-Emitter Charge		-	19		nC
$Q_{gc}$	Gate-Collector Charge		-	75		nC
$t_{d(on)}$	Turn-on Delay Time	$V_{CC} = 400V$ $V_{GE} = 15V$ $I_C = 40A$ $R_G = 10\Omega$ Inductive Load $T_C = 25^\circ C$	-	23	-	ns
$t_r$	Turn-on Rise Time		-	52	-	ns
$t_{d(off)}$	Turn-off Delay Time		-	121	-	ns
$t_f$	Turn-off Fall Time		-	30	-	ns
$E_{on}$	Turn-on Switching Loss		-	1.05	-	mJ
$E_{off}$	Turn-off Switching Loss		-	0.60	-	mJ
$C_{ies}$	Input Capacitance		$V_{CE} = 25V$ $V_{GE} = 0V$ $f = 1MHz$	-	1550	-
$C_{oes}$	Output Capacitance	-		220	-	pF
$C_{res}$	Reverse Transfer Capacitance	-		105	-	pF
$R_{Gint}$	Integrated gate resistor	$f = 1M; V_{pp} = 1V$		1.50		$\Omega$

## Electrical Characteristics of Diode (TC=25°C unless otherwise noted)

Symbol	Parameter	Test Conditions	Min.	Typ.	Max.	Units
$V_F$	Diode Forward Voltage	$I_F = 40A$	-	1.35		V
$t_{rr}$	Diode Reverse Recovery Time	$V_{CE} = 400V$ $I_F = 40A$ $dI_F/dt = 500A/\mu s$	-	100		ns
$I_{rrm}$	Diode peak Reverse Recovery Current		-	16.5		A
$Q_{rr}$	Diode Reverse Recovery Charge		-	980		nC

### Notes:

1. Repetitive Rating: Pulse width limited by maximum junction temperature

**Typical Characteristics**

Fig 1. DC Collector current as a function of case temperature ( $V_{GE} \geq 15V$ ,  $T_j \leq 150^\circ C$ )

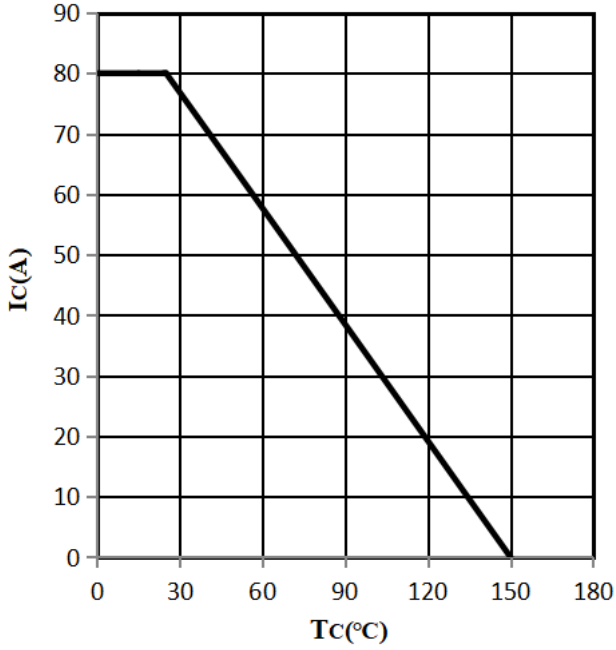

Fig 2. Power dissipation as a function of case temperature ( $T_j \leq 150^\circ C$ )

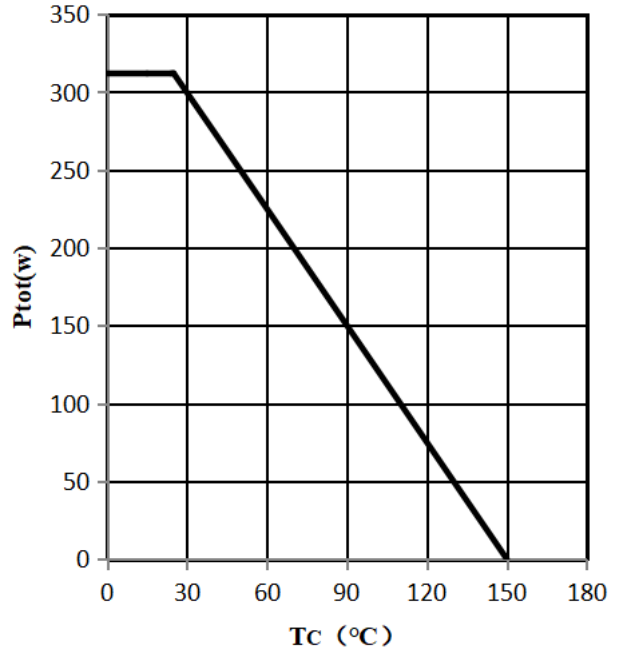

Fig 3. IGBT Forward safe operation area

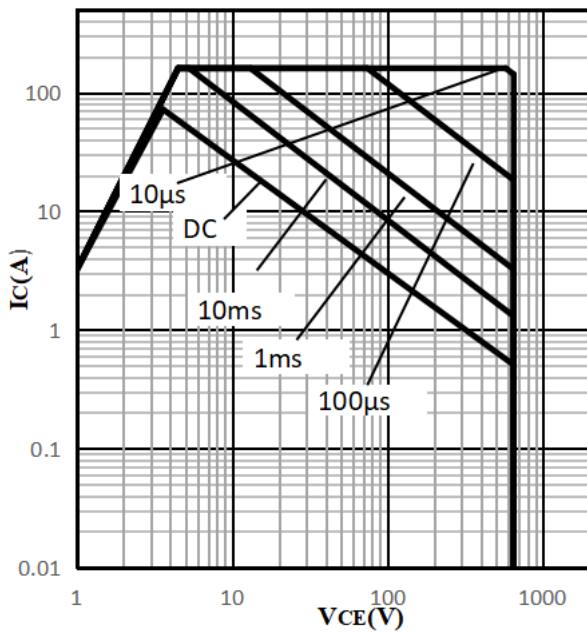
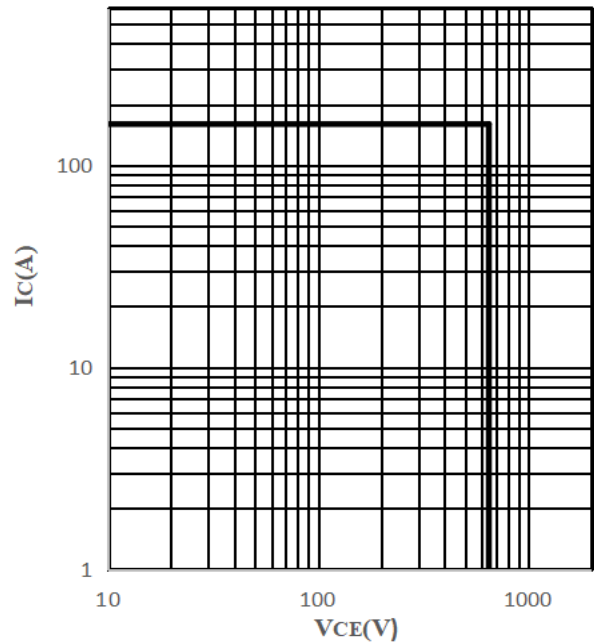

Fig 4. IGBT Reverse safe operation area



**Typical Characteristics**

Fig 5. Typical output characteristic (T<sub>j</sub>=25°C)

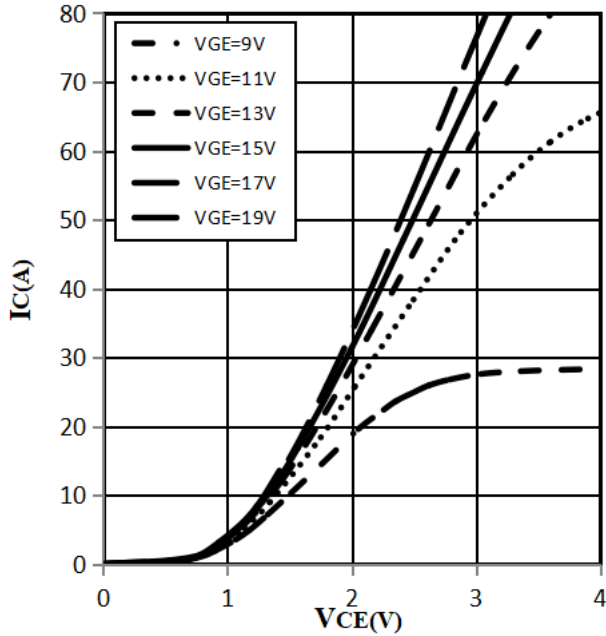

Fig 6. Typical output characteristic (T<sub>j</sub>=125°C)

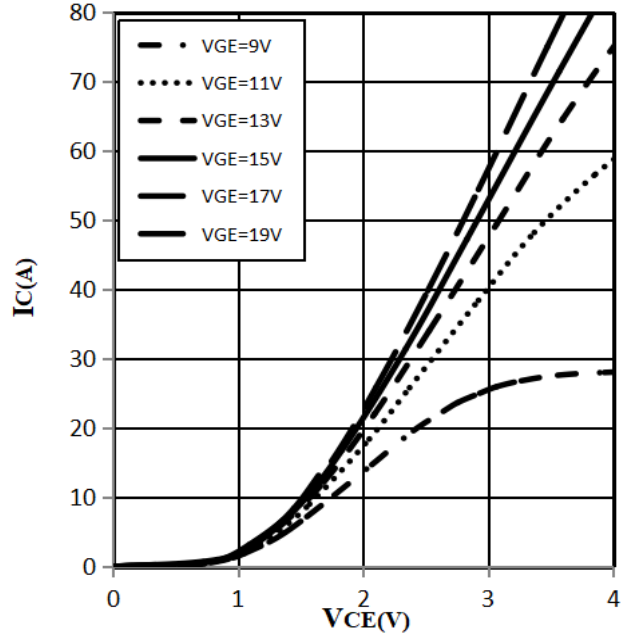

Fig 7. Typical transfer characteristic (V<sub>CE</sub>=20V)

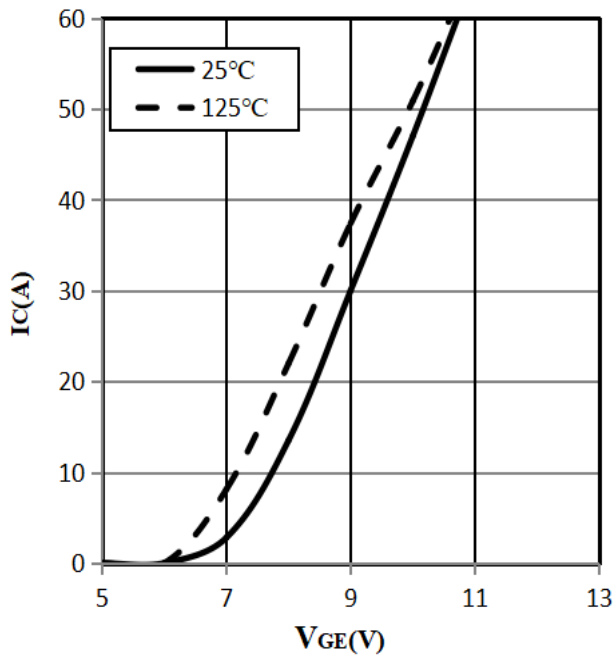
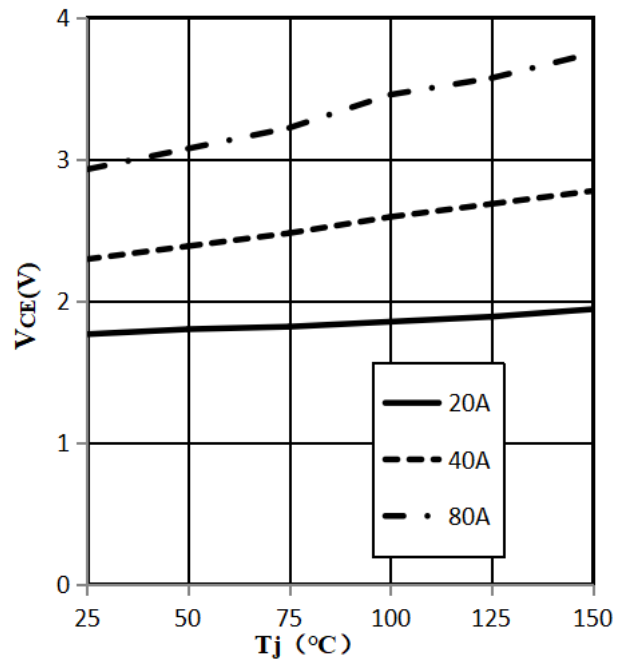

Fig 8. Typical collector-emitter saturation voltage as a function of junction temperature (V<sub>GE</sub>=15V)



**Typical Characteristics**

Fig 9. Typical collector-emitter saturation voltage as a function of  $V_{GE}$  ( $T_j=25^\circ\text{C}$ )

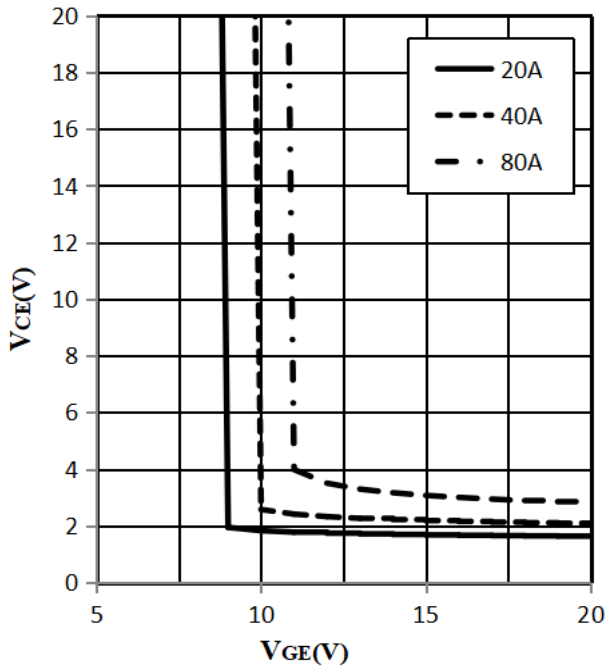

Fig 10. Typical collector-emitter saturation voltage as a function of  $V_{GE}$  ( $T_j=125^\circ\text{C}$ )

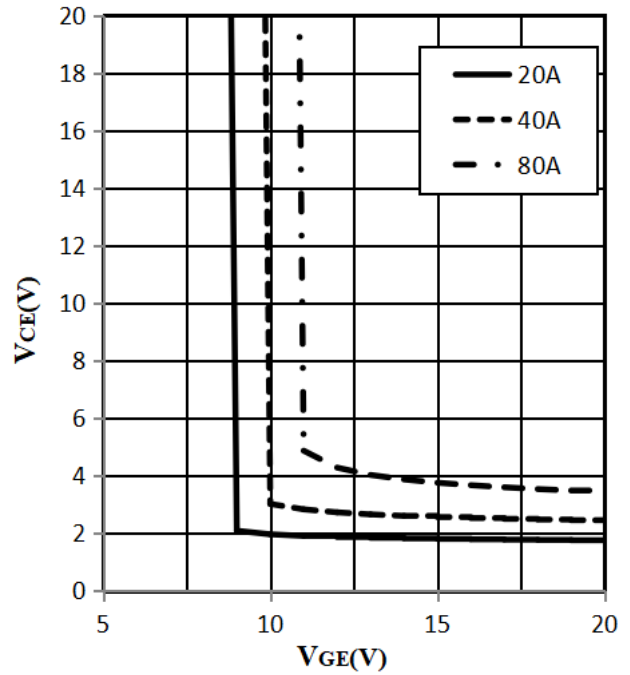

Fig 11. Typical switch energy as a function of  $I_C$  (inductive load,  $T_j=25^\circ\text{C}$ ,  $V_{CE}=400\text{V}$ ,  $V_{GE}=15\text{V}$ ,  $R_G=10\Omega$ )

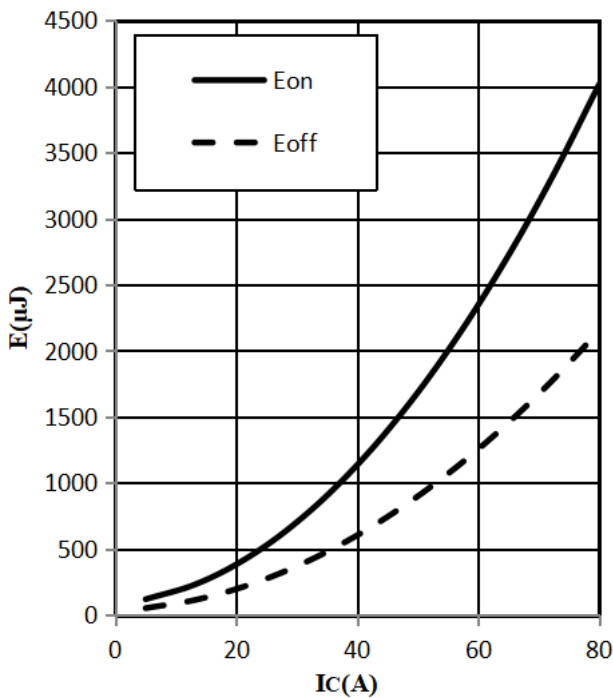
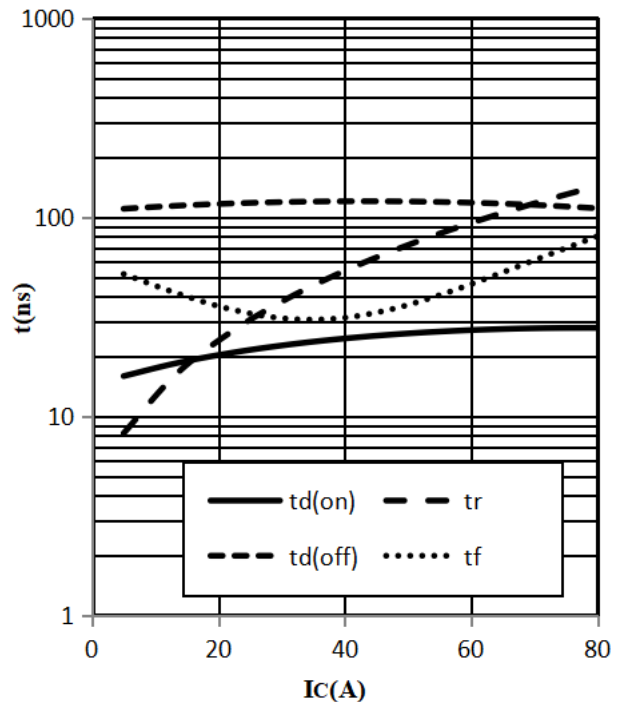

Fig 12. Typical switch time as a function of  $I_C$  (inductive load,  $T_j=25^\circ\text{C}$ ,  $V_{CE}=400\text{V}$ ,  $V_{GE}=15\text{V}$ ,  $R_G=10\Omega$ )



**Typical Characteristics**

Fig 13. Typical switch energy as a function of  $R_G$   
(inductive load,  $T_J=25^\circ\text{C}$ ,  $V_{CE}=400\text{V}$ ,  $V_{GE}=15\text{V}$ ,  $I_C=40\text{A}$ )

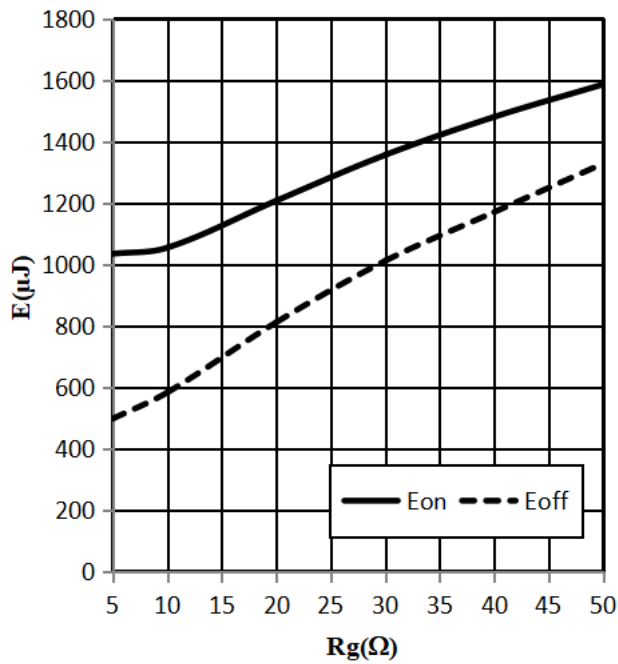

Fig 14. Typical switch time as a function of  $R_G$   
(inductive load,  $T_J=25^\circ\text{C}$ ,  $V_{CE}=400\text{V}$ ,  $V_{GE}=15\text{V}$ ,  $I_C=40\text{A}$ )

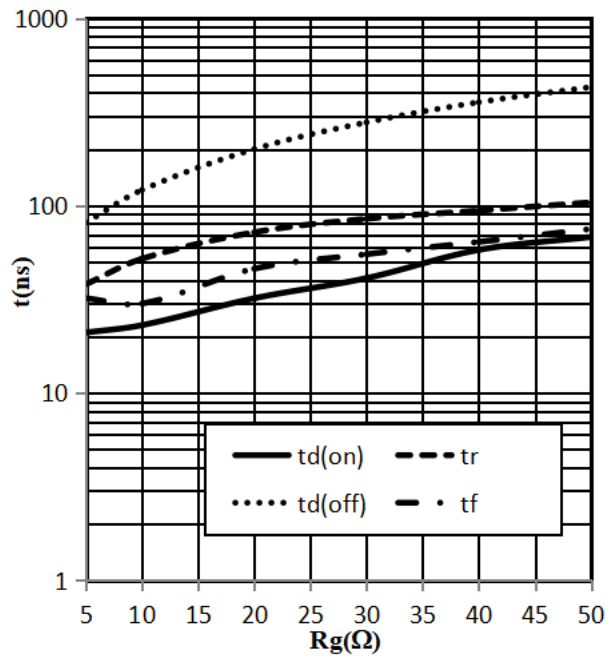

Fig 15. Typical capacitance as a function of collector-emitter voltage ( $V_{GE}=0\text{V}$ ,  $f=1\text{MHz}$ )

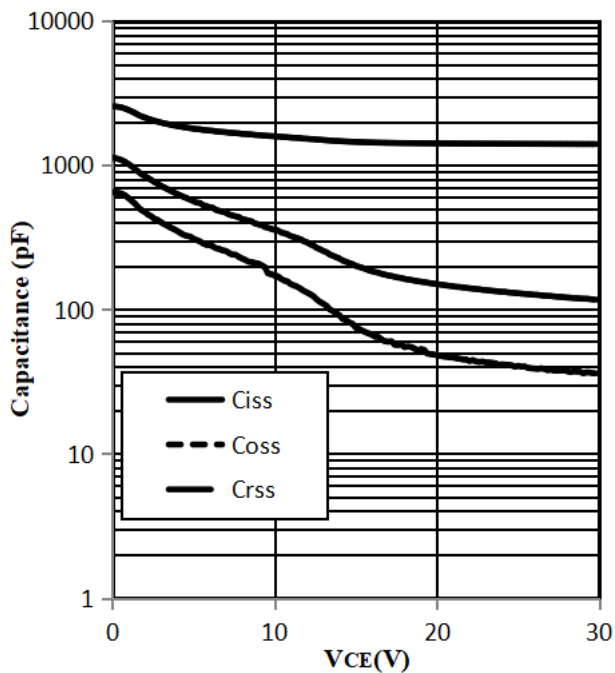
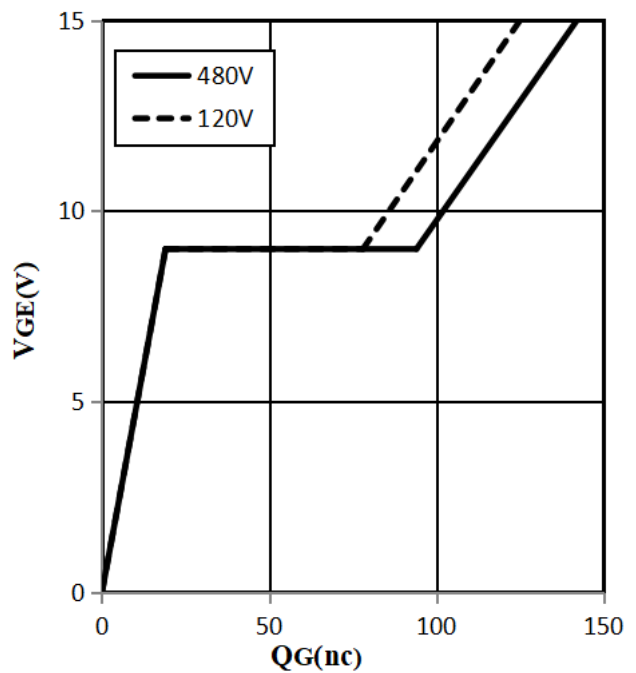

Fig 16. Typical gate charge ( $I_C=40\text{A}$ )



**Typical Characteristics**

Fig 17. Typical diode forward current as a function of forward voltage

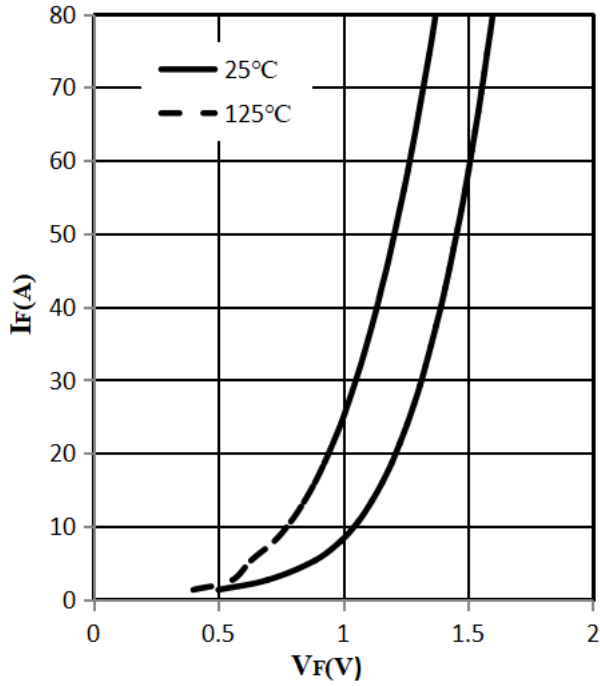

Fig 18. Typical trr as a function of dIF/dt (IF=40A)

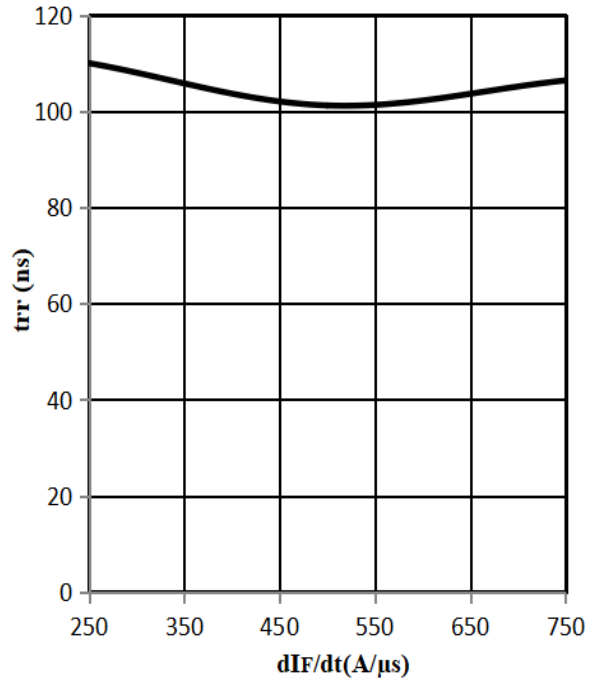

Fig 19. Typical Irrm as a function of dIF/dt (IF=40A)

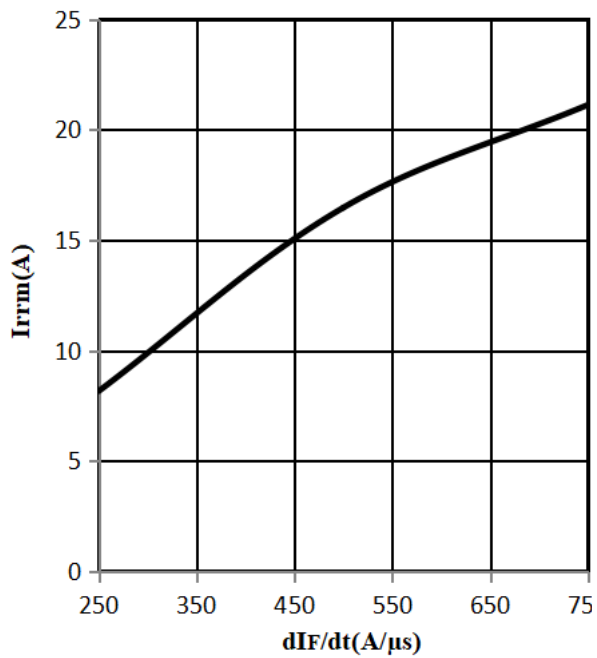
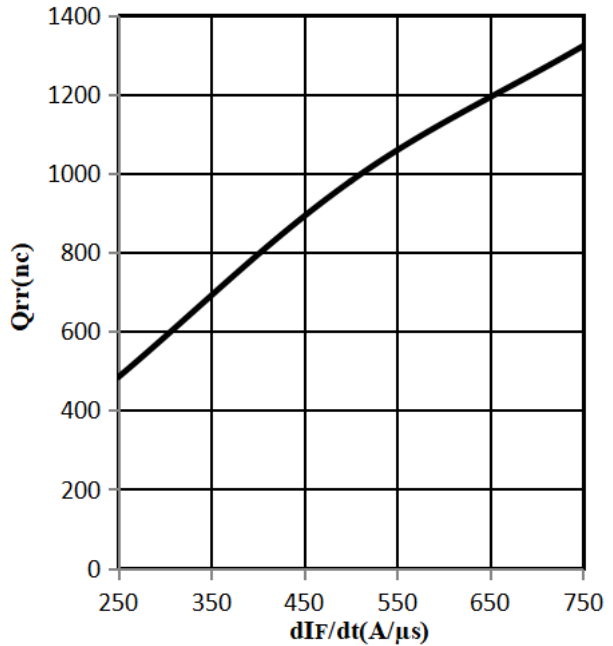
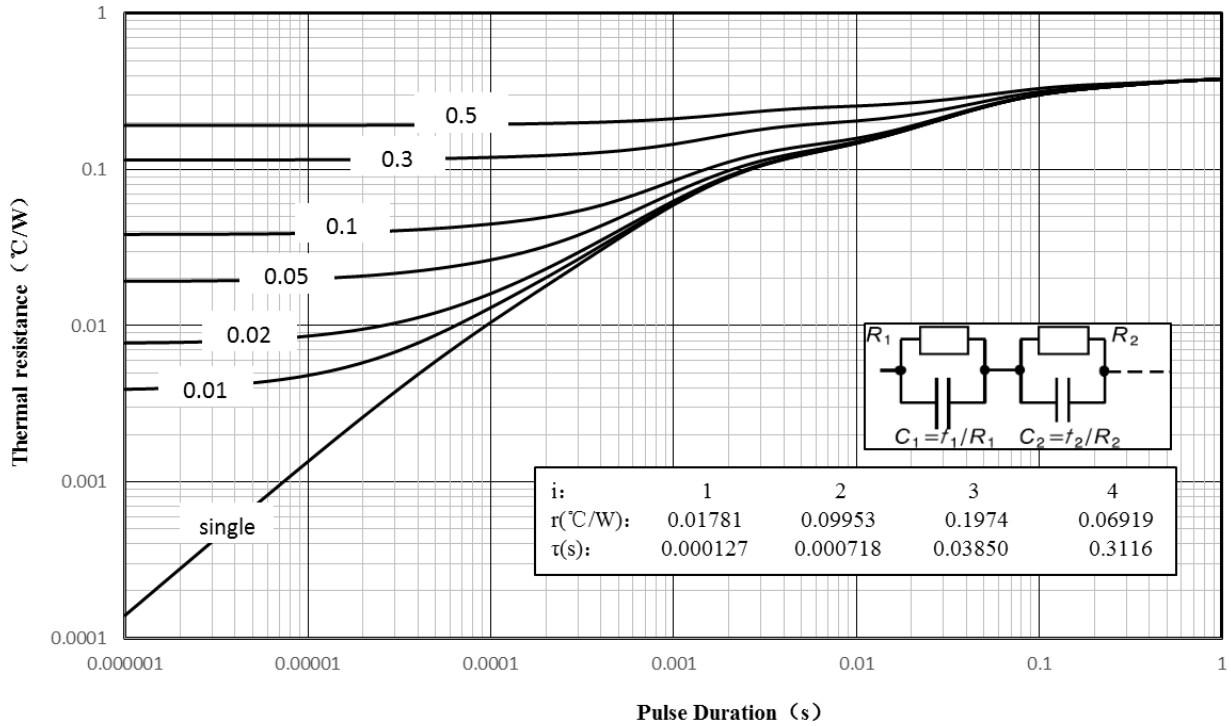

Fig 20. Typical Qrr as a function of dIF/dt (IF=40A)



**Typical Characteristics**

Fig 21. IGBT transient thermal resistance( $D=tp/T$ )





## Package Dimensions

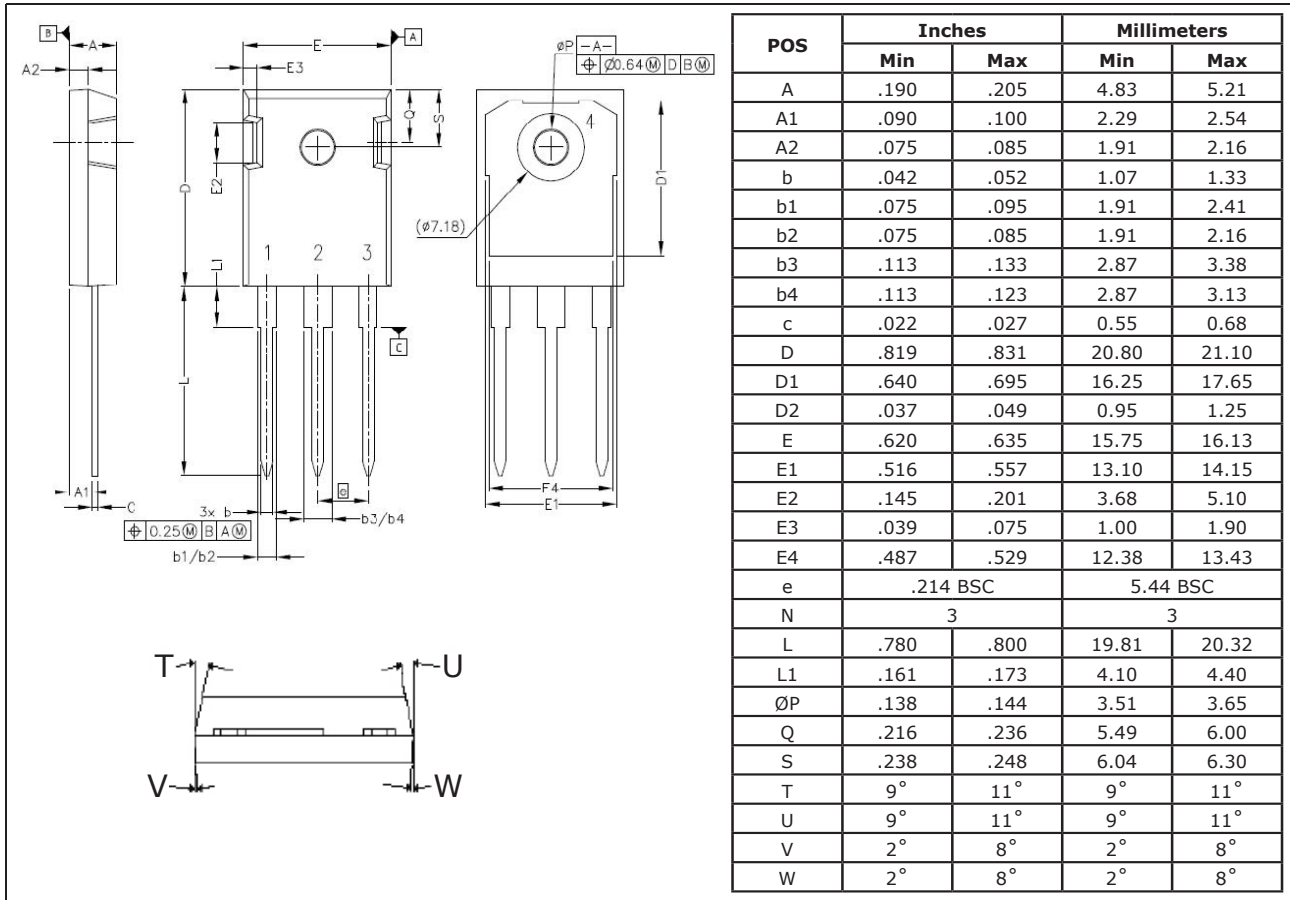

## Ordering information

Order code	Package	Packaging option	Base quantity	Packaging specification
CXG40N65HSEU	TO-247	Tube/BOX	2250pcs / BOX	

## Revision history

Date	Revision	Changes
23-May-2017	1.0	Initial release

## **CAUTION / WARNING**

Information in this document is believed to be accurate and reliable. However, CREATEK does not give any representations or warranties, expressed or implied, as to the accuracy or completeness of such information and shall have no liability for the consequences of use of such information.

Users should independently evaluate the suitability of and test each product selected for their own applications, and CREATEK assumes no liability whatsoever relating to the choice, selection or use of the CREATEK products and services described herein.

CREATEK reserves the right to change or update, without notice, any information contained in this publication; to change, without notice, the design, construction, processing, or specification of any product; and to discontinue or limit production or distribution of any product.

Information in this document supersedes and replaces all information previously supplied.

Products are not designed, authorized or warranted to be suitable for use in medical, military, aircraft, space or life support equipment, nor in applications where failure or malfunction of an CREATEK product can reasonably be expected to result in personal injury, death or severe property or environmental damage. CREATEK accepts no liability for inclusion and/or use of CREATEK products in such equipment or applications and therefore such inclusion and/or use is at the customer's own risk.

This document as well as the item(s) described herein may be subject to export control regulations. Export might require a prior authorization from national authorities.

Resale of CREATEK products with provisions different from the statements and/or technical features set forth in this document shall immediately void any warranty granted by CREATEK for the CREATEK product or service described herein and shall not create or extend in any manner whatsoever, any liability of CREATEK.

CREATEK expressly disclaims all implied warranties regarding the information contained herein, including, but not limited to, any implied warranties of merchantability or fitness for a particular purpose. CREATEK only obligations are those in the CREATEK Standard Terms and Conditions of Sale and in no case will CREATEK be liable for any incidental, indirect, or consequential damages arising from the sale, resale, use, or misuse of its products.

---

Specifications are subject to change without notice

© Copyright 2009, CREATEK Microelectronics

 CREATEK® is a registered trademark of CREATEK Microelectronics

All rights reserved